



WTB16P-1H162120A00

W16

SMALL PHOTOELECTRIC SENSORS

SICK
Sensor Intelligence.



Illustration may differ

Ordering information

| Type | Part no. |
|--------------------|----------|
| WTB16P-1H162120A00 | 1221725 |

Other models and accessories → www.sick.com/W16



Detailed technical data

Features

| | |
|---|---|
| Functional principle | Photoelectric proximity sensor |
| Functional principle detail | Background suppression |
| Sensing range | |
| Sensing range min. | 10 mm |
| Sensing range max. | 1,000 mm |
| Adjustable switching threshold for background suppression | 100 mm ... 1,000 mm |
| Reference object | Object with 90% remission factor (complies with standard white according to DIN 5033) |
| Minimum distance between set sensing range and background (black 6% / white 90%) | 25 mm, at a distance of 400 mm |
| Recommended sensing range for the best performance | 100 mm ... 400 mm |
| Emitted beam | |
| Light source | PinPoint LED |
| Type of light | Visible red light |
| Shape of light spot | Point-shaped |
| Light spot size (distance) | Ø 6 mm (500 mm) |
| Maximum dispersion of the emitted beam around the standardized transmission axis (squint angle) | < +/- 1.0° (at Ta = +23 °C) |

| | |
|------------------------|--|
| Key LED figures | |
| Normative reference | EN 62471:2008-09 IEC 62471:2006, modified |
| LED risk group marking | Free group |
| Wave length | 635 nm |
| Average service life | 100,000 h at $T_a = +25 \text{ }^\circ\text{C}$ |
| Adjustment | |
| Teach-Turn adjustment | BluePilot: For setting the sensing range |
| IO-Link | For configuring the sensor parameters and Smart Task functions |
| Indication | |
| LED blue | BluePilot: sensing range indicator |
| LED green | Operating indicator Static on: power on Flashing: IO-Link mode |
| LED yellow | Status of received light beam Static on: object present Static off: object not present |

Safety-related parameters

| | |
|-------------------------------------|--|
| MTTF_D | 626 years |
| DC_{avg} | 0% |
| T_M (mission time) | 20 years (EN ISO 13849, rate of use: 60 %) |

Communication interface

| | |
|-----------------------------|--|
| IO-Link | ✓, V1.1 |
| Data transmission rate | COM2 (38,4 kBaud) |
| Cycle time | 2.3 ms |
| Process data length | 16 Bit |
| Process data structure | Bit 0 = switching signal Q _{L1} Bit 1 = switching signal Q _{L2} Bit 2 ... 15 = empty |
| VendorID | 26 |
| DeviceID HEX | 0x80015C |
| DeviceID DEC | 8388956 |
| Compatible master port type | A |
| SIO mode support | Yes |

Electrical data

| | |
|-------------------------------------|--|
| Supply voltage U_B | 10 V DC ... 30 V DC ¹⁾ |
| Ripple | ≤ 5 V _{pp} |
| Usage category | DC-12 (According to EN 60947-5-2) DC-13 (According to EN 60947-5-2) |
| Current consumption | ≤ 30 mA, without load. At U _B = 24 V |
| Protection class | III |
| Digital output | |

¹⁾ Limit values.

²⁾ Signal transit time with resistive load in switching mode.

³⁾ With light/dark ratio 1:1.

⁴⁾ This switching output must not be connected to another output.

| | |
|---------------------------------------|---|
| Number | 2 (Complementary) |
| Type | Push-pull: PNP/NPN |
| Switching mode | Light/dark switching |
| Signal voltage PNP HIGH/LOW | Approx. $U_B - 2.5 \text{ V} / 0 \text{ V}$ |
| Signal voltage NPN HIGH/LOW | Approx. $U_B / < 2.5 \text{ V}$ |
| Output current I_{max} | $\leq 100 \text{ mA}$ |
| Circuit protection outputs | Reverse polarity protected Overcurrent and short-circuit protected |
| Response time | $\leq 500 \mu\text{s}$ ²⁾ |
| Repeatability (response time) | 150 μs |
| Switching frequency | 1,000 Hz ³⁾ |
| Pin/Wire assignment | |
| Function of pin 4/black (BK) | Digital output, dark switching, object present → output \bar{Q}_{L1} LOW; IO-Link communication C ⁴⁾ |
| Function of pin 4/black (BK) – detail | The pin 4 function of the sensor can be configured, Additional possible settings via IO-Link |
| Function of pin 2/white (WH) | Digital output, light switching, object present → output Q_{L1} HIGH ⁴⁾ |
| Function of pin 2/white (WH) – detail | The pin 2 function of the sensor can be configured, Additional possible settings via IO-Link |

¹⁾ Limit values.

²⁾ Signal transit time with resistive load in switching mode.

³⁾ With light/dark ratio 1:1.

⁴⁾ This switching output must not be connected to another output.

Mechanical data

| | |
|---|--|
| Housing | Rectangular |
| Dimensions (W x H x D) | 20 mm x 55.7 mm x 42 mm |
| Connection | Cable, 4-wire, 2 m |
| Connection detail | |
| Deep-freeze property | Do not bend below 0 °C |
| Conductor size | 0.14 mm ² |
| Cable diameter | ∅ 4.8 mm |
| Length of cable (L) | 2 m |
| Bending radius | For flexible use > 12 x cable diameter |
| Bending cycles | 1,000,000 |
| Material | |
| Housing | Plastic, VISTAL® |
| Front screen | Plastic, PMMA |
| Cable | Plastic, PVC |
| Weight | Approx. 100 g |
| Maximum tightening torque of the fixing screws | 1.3 Nm |

Ambient data

| | |
|-------------------------|---|
| Enclosure rating | IP66 (EN 60529) IP67 (EN 60529) IP69 (EN 60529) ¹⁾ |
|-------------------------|---|

¹⁾ Replaces IP69K with ISO 20653: 2013-03.

| | |
|--|--|
| Ambient operating temperature | -40 °C ... +60 °C |
| Ambient temperature, storage | -40 °C ... +75 °C |
| Shock resistance | 50 g, 11 ms (25 positive and 25 negative shocks per axis, for X, Y, Z axes, 150 shocks in total (EN60068-2-27)) 50 g, 6 ms (5,000 positive and 5,000 negative shocks per axis, for X, Y, Z axes, 30,000 shocks in total (EN60068-2-27)) |
| Vibration resistance | 10 Hz ... 2,000 Hz (Amplitude 0.5 mm / 10 g, 20 sweeps per axis, for X, Y, Z axes, 1 octave/min, (EN60068-2-6)) |
| Air humidity | 35 % ... 95 %, relative humidity (no condensation) |
| Electromagnetic compatibility (EMC) | EN 60947-5-2 |
| Resistance to cleaning agent | ECOLAB |
| UL File No. | NRKH.E181493 & NRKH7.E181493 |

¹⁾ Replaces IP69K with ISO 20653: 2013-03.

Smart Task

| | |
|---------------------------------|---|
| Smart Task name | Base logics |
| Logic function | Direct AND OR Window Hysteresis |
| Timer function | Deactivated Switch-on delay Off delay ON and OFF delay Impulse (one shot) |
| Inverter | Yes |
| Switching frequency | SIO Logic: 800 Hz ¹⁾ IOL: 650 Hz ²⁾ |
| Response time | SIO Logic: 600 µs ¹⁾ IOL: 750 µs ²⁾ |
| Repeatability | SIO Logic: 300 µs ¹⁾ IOL: 400 µs ²⁾ |
| Switching signal | |
| Switching signal Q_{L1} | Switching output |
| Switching signal \bar{Q}_{L1} | Switching output |

¹⁾ Use of Smart Task functions without IO-Link communication (SIO mode).

²⁾ Use of Smart Task functions with IO-Link communication function.

Diagnosis

| | |
|-------------------------|-----|
| Device status | Yes |
| Quality of teach | Yes |

Classifications

| | |
|---------------------|----------|
| ECLASS 5.0 | 27270904 |
| ECLASS 5.1.4 | 27270904 |
| ECLASS 6.0 | 27270904 |
| ECLASS 6.2 | 27270904 |
| ECLASS 7.0 | 27270904 |

| | |
|-----------------------|----------|
| ECLASS 8.0 | 27270904 |
| ECLASS 8.1 | 27270904 |
| ECLASS 9.0 | 27270904 |
| ECLASS 10.0 | 27270904 |
| ECLASS 11.0 | 27270904 |
| ECLASS 12.0 | 27270903 |
| ETIM 5.0 | EC002719 |
| ETIM 6.0 | EC002719 |
| ETIM 7.0 | EC002719 |
| ETIM 8.0 | EC002719 |
| UNSPSC 16.0901 | 39121528 |

Dimensional drawing (Dimensions in mm (inch))

Dimensional drawing, sensor

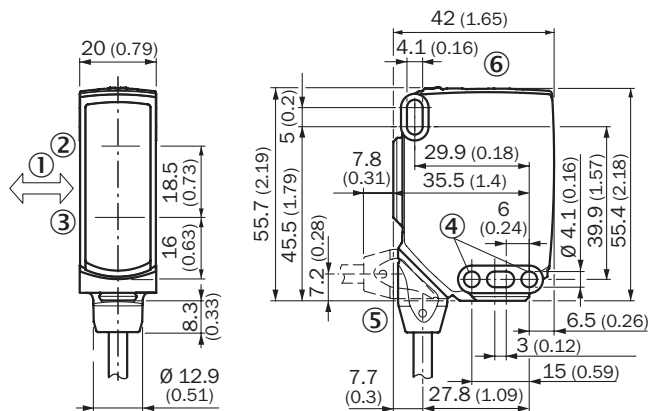

- ① Standard direction of the material being detected
- ② Center of optical axis, sender
- ③ Center of optical axis, receiver
- ④ Mounting hole, \varnothing 4.1 mm
- ⑤ Connection
- ⑥ Display and adjustment elements

Adjustments

Display and adjustment elements

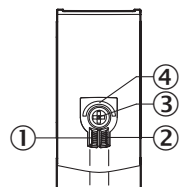

- ① LED indicator green
- ② LED indicator yellow
- ③ Teach-Turn adjustment
- ④ LED blue

Connection type

Cable, 4-wire

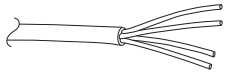

Connection diagram

Cd-389



Truth table

Push-pull: PNP/NPN – dark switching \bar{Q}

| | Dark switching \bar{Q} (normally closed (upper switch), normally open (lower switch)) | |
|-------------------------|---|-----------------------------|
| | Object not present → Output HIGH | Object present → Output LOW |
| Light receive | ✗ | ✓ |
| Light receive indicator | ✗ | ☉ |
| Load resistance to L+ | ✗ | ⚠ |
| Load resistance to M | ⚠ | ✗ |
| | | |

Push-pull: PNP/NPN - light switching Q

| | Light switching Q (normally open (upper switch), normally closed (lower switch)) | |
|-------------------------|--|------------------------------|
| | Object not present → Output LOW | Object present → Output HIGH |
| Light receive | ✗ | ✓ |
| Light receive indicator | ✗ | ☉ |
| Load resistance to L+ | ⚠ | ✗ |
| Load resistance to M | ✗ | ⚠ |
| | | |

Characteristic curve

Minimum distance in mm (y) between the set sensing range and white background (90 % remission)

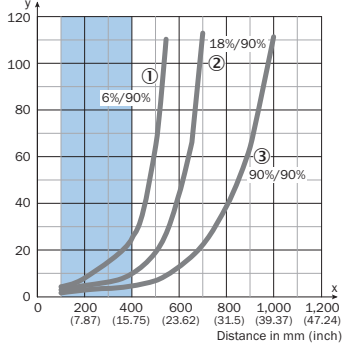

Example:
Safe suppression of the background

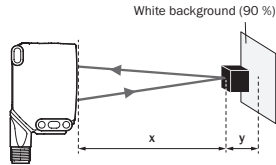

Black object (6 % remission)
Set sensing range $x = 400$ mm
Needed minimum distance to white background $y = 25$ mm

Recommended sensing range for the best performance

- ① Black object, 6% remission factor
- ② Gray object, 18% remission factor
- ③ White object, 90% remission factor

Light spot size

WTB16P-xxxxx1xx, WTB16P-xxxxxAxx

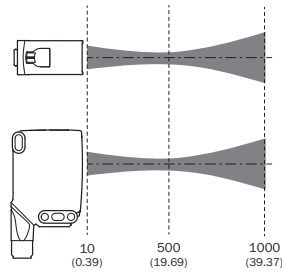
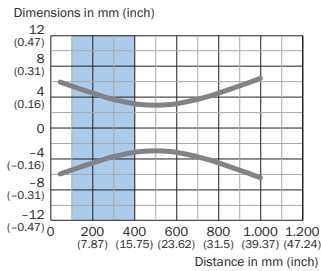

Recommended sensing range for the best performance

Sensing range diagram

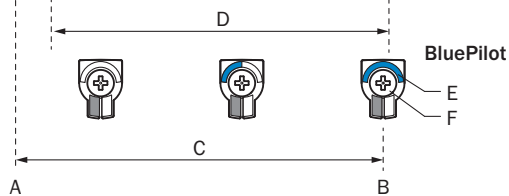
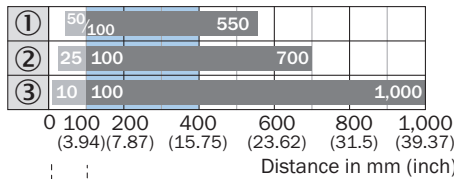



Recommended sensing range for the best performance

| | |
|---|---|
| 1 | Black object, 6% remission factor |
| 2 | Gray object, 18% remission factor |
| 3 | White object, 90% remission factor |
| A | Sensing range min. in mm |
| B | Sensing range max. in mm |
| C | Field of view |
| D | Adjustable switching threshold for background suppression |
| E | Sensing range indicator |
| F | Teach-Turn adjustment |

Recommended accessories

Other models and accessories → www.sick.com/W16

| | Brief description | Type | Part no. |
|---|--|-------------|----------|
| Universal bar clamp systems | | | |
|  | Plate N02 for universal clamp bracket, Zinc plated steel (sheet), Zinc die cast (clamping bracket), Universal clamp (5322626), mounting hardware | BEF-KHS-N02 | 2051608 |
| Mounting brackets and plates | | | |
|  | Adapter for mounting W16 sensors in existing W14-2/W18-3 installations or L25 sensors in existing L28 installations, plastic, fastening screws included | BEF-AP-W16 | 2095677 |
| Others | | | |
|  | <ul style="list-style-type: none"> • Connection type head A: Male connector, M8, 4-pin, straight, A-coded • Description: Unshielded • Connection systems: Screw-type terminals • Permitted cross-section: 0.14 mm² ... 0.5 mm² | STE-0804-G | 6037323 |

Recommended services

Additional services → www.sick.com/W16

| | Type | Part no. |
|--|------------------------|------------|
| Function Block Factory | | |
| <ul style="list-style-type: none"> • Description: The Function Block Factory supports common programmable logic controllers (PLCs) from various manufacturers, such as Siemens, Beckhoff, Rockwell Automation and B&R. More information on the FBF can be found <a _blank"="" href="https://fbf.cloud.sick.com target=">here. • Note: You can configure your function block at <a _blank"="" href="https://fbf.cloud.sick.com target=">Function Block Factory. As a login please use your SICK ID. | Function Block Factory | On request |

SICK AT A GLANCE

SICK is one of the leading manufacturers of intelligent sensors and sensor solutions for industrial applications. A unique range of products and services creates the perfect basis for controlling processes securely and efficiently, protecting individuals from accidents and preventing damage to the environment.

We have extensive experience in a wide range of industries and understand their processes and requirements. With intelligent sensors, we can deliver exactly what our customers need. In application centers in Europe, Asia and North America, system solutions are tested and optimized in accordance with customer specifications. All this makes us a reliable supplier and development partner.

Comprehensive services complete our offering: SICK LifeTime Services provide support throughout the machine life cycle and ensure safety and productivity.

For us, that is “Sensor Intelligence.”

WORLDWIDE PRESENCE:

Contacts and other locations –www.sick.com