



DBS60E-S4EN02500

DBS60

INCREMENTAL ENCODERS

SICK
Sensor Intelligence.



Illustration may differ



Ordering information

Type	Part no.
DBS60E-S4EN02500	1076373

Other models and accessories → www.sick.com/DBS60

Detailed technical data

Safety-related parameters

MTTF_D (mean time to dangerous failure)	500 years (EN ISO 13849-1) ¹⁾
--	--

¹⁾ This product is a standard product and does not constitute a safety component as defined in the Machinery Directive. Calculation based on nominal load of components, average ambient temperature 40 °C, frequency of use 8760 h/a. All electronic failures are considered hazardous. For more information, see document no. 8015532.

Performance

Pulses per revolution	2,500
Measuring step	≤ 90°, electric/pulses per revolution
Measuring step deviation	± 18° / pulses per revolution
Error limits	Measuring step deviation x 3
Duty cycle	≤ 0.5 ± 5 %

Interfaces

Communication interface	Incremental
Communication Interface detail	HTL / Push pull
Number of signal channels	6-channel
Initialization time	< 5 ms ¹⁾
Output frequency	+ 300 kHz ²⁾
Load current	≤ 30 mA, per channel
Power consumption	≤ 1 W (without load)

¹⁾ Valid signals can be read once this time has elapsed.

²⁾ Up to 450 kHz on request.

Electronics

Connection type	Cable, 8-wire, universal, 10 m ¹⁾
Supply voltage	10 ... 27 V
Reference signal, number	1
Reference signal, position	90°, electric, logically gated with A and B
Reverse polarity protection	✓

¹⁾ The universal cable connection is positioned so that it is possible to lay it without bends in a radial or axial direction.

²⁾ Short-circuit opposite to another channel, US or GND permissible for maximum 30 s.

Short-circuit protection of the outputs

✓²⁾

¹⁾ The universal cable connection is positioned so that it is possible to lay it without bends in a radial or axial direction.

²⁾ Short-circuit opposite to another channel, US or GND permissible for maximum 30 s.

Mechanics

Mechanical design	Solid shaft, face mount flange
Shaft diameter	10 mm With face
Shaft length	19 mm
Flange type / stator coupling	Flange with 3 x M3 and 3 x M4
Weight	+ 0.3 kg ¹⁾
Shaft material	Stainless steel
Flange material	Aluminum
Housing material	Aluminum
Material, cable	PVC
Start up torque	+ 1.2 Ncm (+20 °C)
Operating torque	1.1 Ncm (+20 °C)
Permissible shaft loading	100 N (radial) ²⁾ 50 N (axial) ²⁾
Operating speed	6,000 min ⁻¹ ³⁾
Maximum operating speed	9,000 min ⁻¹ ⁴⁾
Moment of inertia of the rotor	33 gcm ²
Bearing lifetime	3.6 x 10 ⁹ revolutions
Angular acceleration	≤ 500,000 rad/s ²

¹⁾ Based on encoder with male connector or cable with male connector.

²⁾ Higher values are possible using limited bearing life.

³⁾ Allow for self-heating of 3.2 K per 1,000 rpm when designing the operating temperature range.

⁴⁾ Maximum speed which does not cause mechanical damage to the encoder. Impact on the service life and signal quality is possible. Please note the maximum output frequency.

Ambient data

EMC	According to EN 61000-6-2 and EN 61000-6-3
Enclosure rating	IP67, housing side (IEC 60529) IP65, shaft side (IEC 60529)
Permissible relative humidity	90 % (Condensation not permitted)
Operating temperature range	-20 °C ... +85 °C ¹⁾
Storage temperature range	-40 °C ... +100 °C, without package
Resistance to shocks	250 g, 3 ms (EN 60068-2-27)
Resistance to vibration	30 g, 10 Hz ... 2,000 Hz (EN 60068-2-6)

¹⁾ These values relate to all mechanical versions including recommended accessories unless otherwise noted.

Classifications

ECLASS 5.0	27270501
ECLASS 5.1.4	27270501
ECLASS 6.0	27270590

ECLASS 6.2	27270590
ECLASS 7.0	27270501
ECLASS 8.0	27270501
ECLASS 8.1	27270501
ECLASS 9.0	27270501
ECLASS 10.0	27270501
ECLASS 11.0	27270501
ECLASS 12.0	27270501
ETIM 5.0	EC001486
ETIM 6.0	EC001486
ETIM 7.0	EC001486
ETIM 8.0	EC001486
UNSPSC 16.0901	41112113

Dimensional drawing (Dimensions in mm (inch))



PIN assignment

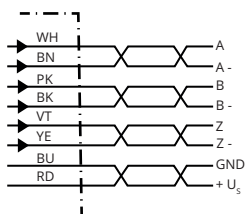

Wire colors (cable connection)	Male connector M12, 8-pin	Male connector M23, 12-pin	TTL/HTL 6-channel signal	Explanation
Brown	1	6	A-	Signal wire
White	2	5	A	Signal wire

Wire colors (cable connection)	Male connector M12, 8-pin	Male connector M23, 12-pin	TTL/HTL 6-channel signal	Explanation
Black	3	1	B-	Signal wire
Pink	4	8	B	Signal wire
Yellow	5	4	Z-	Signal wire
Purple	6	3	Z	Signal wire
Blue	7	10	GND	Ground connection
Red	8	12	+U _s	Supply voltage
-	-	9	Not assigned	Not assigned
-	-	2	Not assigned	Not assigned
-	-	11	Not assigned	Not assigned
-	-	7	Not assigned	Not assigned
Screen	Screen	Screen	Screen	Screen connected to encoder housing

Diagrams

Pulses per revolution

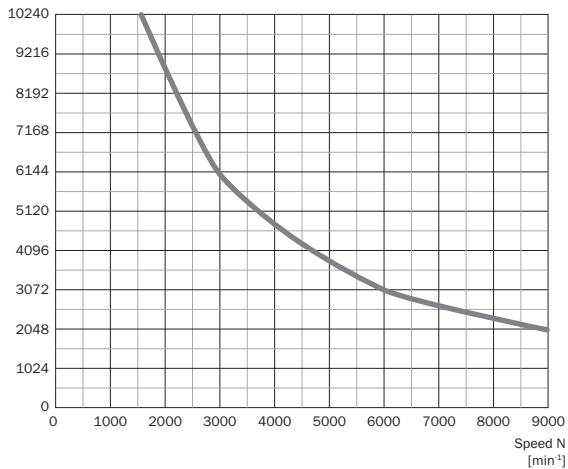

Signal outputs for electrical interfaces TTL and HTL



Cw with view on the encoder shaft in direction "A", compare dimensional drawing.

Supply voltage	Output
4,5 V ... 5,5 V	TTL
10 V ... 30 V	TTL
10 V ... 27 V	HTL
4,5 V ... 30 V	TTL/HTL universal
4,5 V ... 30 V	TTL

Operation note

Solid shaft, face mount flange

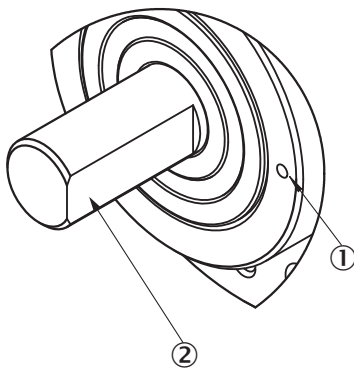

- ① Zero pulse mark on flange
- ② Zero pulse active when the surface of the shaft shows the zero pulse mark on the flange











Recommended accessories

Other models and accessories → www.sick.com/DBS60

	Brief description	Type	Part no.
Others			
	<ul style="list-style-type: none"> • Connection type head A: Flying leads • Connection type head B: Flying leads • Signal type: SSI, Incremental, HIPERFACE® • Items supplied: By the meter • Cable: 8-wire, PUR, halogen-free • Description: SSI, Incremental, HIPERFACE®, shielded 	LTG-2308-MWENC	6027529
	<ul style="list-style-type: none"> • Connection type head A: Flying leads • Connection type head B: Flying leads • Signal type: SSI, Incremental • Items supplied: By the meter • Cable: 11-wire, PUR • Description: SSI, Incremental, shielded 	LTG-2411-MW	6027530
	<ul style="list-style-type: none"> • Connection type head A: Flying leads • Connection type head B: Flying leads • Signal type: SSI, Incremental • Items supplied: By the meter • Cable: 12-wire, PUR, halogen-free • Description: SSI, Incremental, shielded 	LTG-2512-MW	6027531
	<ul style="list-style-type: none"> • Connection type head A: Flying leads • Connection type head B: Flying leads • Signal type: SSI, TTL, HTL, Incremental • Items supplied: By the meter • Cable: 12-wire, UV and saltwater-resistant, PUR, halogen-free • Description: SSI, TTL, HTL, Incremental, shielded, Head A: cable Head B: cable Cable: suitable for drag chain, PUR, halogen-free, shielded, UV and saltwater resistant, 4 x 2 x 0.25 mm² + 2 x 0.5 mm² + 2 x 0.14 mm², Ø 7.8 mm 	LTG-2612-MW	6028516
	<ul style="list-style-type: none"> • Product family: Assembly accessories • Description: Bearing block for servo and face mount flange encoder. The heavy-duty bearing block is used to absorb very large radial and axial shaft loads. Particularly when using belt pulleys, chain sprockets, friction wheels. Operating speed max. 4,000 rpm⁻¹, axial shaft load 150 N, radial shaft load 250 N, bearing service life 3.6 x 10⁹ revolutions 	BEF-FA-LB1210	2044591
	<ul style="list-style-type: none"> • Product segment: Shaft adaptation • Product family: Shaft couplings • Description: Bellows coupling, shaft diameter 6 mm / 10 mm, maximum shaft offset: radial ± 0.25 mm, axial ± 0.4 mm, angular +/- 4°; max. speed 10,000 rpm, -30 °C to +120 °C, max. torque 120 Ncm; material: stainless steel bellows, aluminum hub 	KUP-0610-B	5312982
	<ul style="list-style-type: none"> • Product segment: Shaft adaptation • Product family: Shaft couplings • Description: Spring washer coupling, shaft diameter 6 mm / 10 mm, Maximum shaft offset: radial +/- 0.3 mm, axial +/- 0.4 mm, angular +/- 2.5°; max. speed 12,000 rpm, -10° to +80 °C, max. torque 60 Ncm; material: aluminum flange, glass fiber-reinforced polyamide membrane and hardened steel coupling pin 	KUP-0610-F	5312985
	BEF-OR-053-040	BEF-OR-053-040	2064061
	BEF-OR-083-050	BEF-OR-083-050	2064076
	BEF-MK-LB	BEF-MK-LB	5320872
	BEF-OR-145-050	BEF-OR-145-050	2064074
	<ul style="list-style-type: none"> • Product segment: Shaft adaptation • Product family: Shaft couplings • Description: Double loop coupling, shaft diameter 6 mm / 10 mm, max. shaft offset: radially +/- 2,5 mm, axially +/-3 mm, angle +/- 10 degrees;max. speed 3.000 rpm, - 30 to +80 degrees Celsius, torsional spring stiffness of 25 Nm/rad 	KUP-0610-D	5326697

	Brief description	Type	Part no.
	<ul style="list-style-type: none"> Product segment: Shaft adaptation Product family: Shaft couplings Description: Bar coupling, shaft diameter 6 mm / 10 mm, max. shaft offset: radial $\pm 0,3$ mm, axial $\pm 0,3$ mm, angular $\pm 3^\circ$; max. speed 10.000 rpm, -10° to $+80^\circ$ °C, max. torque: 80 Ncm, material: fiber-glass reinforced polyamide, aluminum hub 	KUP-0610-S	2056407
	<ul style="list-style-type: none"> Product segment: Shaft adaptation Product family: Shaft couplings Description: Claw coupling, shaft diameter 6 mm / 10 mm, damping element 80 shore blue, maximum shaft offset: radial ± 0.22 mm, axial ± 1 mm angular $\pm 1.3^\circ$, max. speed 19,000 rpm, angle of twist max. 10°, -30° °C to $+80^\circ$ °C, max. torque 800 Ncm, tightening torque of screws: ISO 4029 150 Ncm, material: aluminum flange, damping element: polyurethane 	KUP-0610-J	2127056
	<ul style="list-style-type: none"> Product family: Brackets Description: Mounting bracket for encoder with spigot 36 mm for face mount flange Items supplied: Mounting kit included 	BEF-WF-36	2029164
	<ul style="list-style-type: none"> Product family: Flanges and nozzles Description: Flange adapter, adaptation of face mount flange with 36 mm centering hub to 58 mm square mounting plate with shock absorbers, aluminum Material: Aluminum Details: Aluminum 	BEF-FA-036-060RSA	2029163
	<ul style="list-style-type: none"> Product family: Flanges and nozzles Description: Flange adapter, adaptation of face mount flange with 36 mm centering hub to 60 mm square mounting plate, aluminum, including 3 flat head screws M4 x 8 Material: Aluminum Details: Aluminum Items supplied: Including 3 countersunk screws M4 x 8 	BEF-FA-036-060REC	2029162
	<ul style="list-style-type: none"> Product family: Flanges and nozzles Description: Flange adapter, adaptation of face mount flange with 36 mm centering hub to 100 mm servo flange with 60 mm centering hub, aluminum Material: Aluminum Details: Aluminum 	BEF-FA-036-100	2029161
	<ul style="list-style-type: none"> Product family: Flanges and nozzles Description: Flange adapter, adaptation of face mount flange with 36 mm centering hub to 50 mm servo flange, aluminum, including 3 flat head screws M4 x 10 Material: Aluminum Details: Aluminum Items supplied: Including 3 countersunk screws M3 x 10 	BEF-FA-036-050	2029160
	<ul style="list-style-type: none"> Product family: Flanges and nozzles Description: Flange adapter, adaptation of face mount flange with 36 mm centering hub to 63 mm square mounting plate, aluminum, including 3 flat head screws M4 x 10 Material: Aluminum Details: Aluminum Items supplied: Including 3 countersunk screws M3 x 10 	BEF-FA-036-063REC	2034225
	<ul style="list-style-type: none"> Product segment: Measuring wheels and measuring wheel mechanics Product family: Measuring wheels Description: Aluminium measuring wheel with O-ring (NBR70) for 10 mm solid shaft, circumference 300 mm 	BEF-MR010030R	2049278
	<ul style="list-style-type: none"> Product segment: Measuring wheels and measuring wheel mechanics Product family: Measuring wheels Description: Aluminium measuring wheel with O-ring (NBR70) for 10 mm solid shaft, circumference 200 mm 	BEF-MR010020R	2055224
	<ul style="list-style-type: none"> Product segment: Measuring wheels and measuring wheel mechanics Product family: Measuring wheels Description: Measuring wheel with O-ring (NBR70) for 10 mm solid shaft, circumference 500 mm 	BEF-MR010050R	2055227

	Brief description	Type	Part no.
	<ul style="list-style-type: none"> Product segment: Shaft adaptation Product family: Shaft couplings Description: Bar coupling, shaft diameter 10 mm / 10 mm; maximum shaft offset: radial ± 0.3 mm, axial ± 0.2 mm, angular $\pm 3^\circ$; speed 10,000 rpm, -10° to $+80^\circ$ Celsius, max. torque 80 Ncm; material: glass fiber-reinforced polyamide, aluminum hub 	KUP-1010-S	2056408
	<ul style="list-style-type: none"> Product family: Assembly accessories Description: Flange adapter (adapts size 60 face mount flange encoder to bearing block with part. no. 2044591) 	BEF-FA-036-050-019	2063378
	<ul style="list-style-type: none"> Product segment: Measuring wheels and measuring wheel mechanics Product family: Measuring wheel mechanics Description: SICK modular measuring wheel system for face mount flange encoder with S4 mechanical design (10 mm x 19 mm solid shaft), e.g., DFS60-S4: with O-ring measuring wheel, circumference 200 mm Suitable for: Face mount flange encoder DFS60, DBS60, AFM60, AFS60, mechanical design S4 (solid shaft 10 mm x 19 mm) 	BEF-MRS-10-U	2085714
	<ul style="list-style-type: none"> Product segment: Measuring wheels and measuring wheel mechanics Product family: Measuring wheels Description: Aluminum measuring wheel with cross-knurled surface for 10 mm solid shaft, circumference 500 mm 	BEF-MR10500AK	4084733
	<ul style="list-style-type: none"> Product segment: Measuring wheels and measuring wheel mechanics Product family: Measuring wheels Description: Aluminum measuring wheel with smooth polyurethane surface for 10 mm solid shaft, circumference 500 mm 	BEF-MR10500AP	4084734
	<ul style="list-style-type: none"> Product segment: Measuring wheels and measuring wheel mechanics Product family: Measuring wheels Description: Aluminum measuring wheel with ridged polyurethane surface for 10 mm solid shaft, circumference 200 mm 	BEF-MR10200APG	4084740
	BEF-MR10200APN	BEF-MR10200APN	4084739
	<ul style="list-style-type: none"> Product segment: Measuring wheels and measuring wheel mechanics Product family: Measuring wheels Description: Aluminum measuring wheel with smooth polyurethane surface for 10 mm solid shaft, circumference 200 mm 	BEF-MR10200AP	4084738
	<ul style="list-style-type: none"> Product segment: Measuring wheels and measuring wheel mechanics Product family: Measuring wheels Description: Aluminum measuring wheel with cross-knurled surface for 10 mm solid shaft, circumference 200 mm 	BEF-MR10200AK	4084737
	<ul style="list-style-type: none"> Product segment: Measuring wheels and measuring wheel mechanics Product family: Measuring wheels Description: Aluminum measuring wheel with ridged polyurethane surface for 10 mm solid shaft, circumference 500 mm 	BEF-MR10500APG	4084736
	<ul style="list-style-type: none"> Product segment: Measuring wheels and measuring wheel mechanics Product family: Measuring wheels Description: Aluminum measuring wheel with studded polyurethane surface for 10 mm solid shaft, circumference 500 mm 	BEF-MR10500APN	4084735
	<ul style="list-style-type: none"> Product family: Brackets Description: Mounting angle spring-loaded, for flange with centering collar 36 mm, working temperature range -40° ... $+120^\circ$ C Details: Aluminum 	BEF-WF36F	4084775
	<ul style="list-style-type: none"> Product segment: Shaft adaptation Product family: Shaft couplings Description: Bellows coupling, shaft diameter 10 mm/10 mm; maximum shaft offset: radial ± 0.25 mm, axial ± 0.4 mm, angular $\pm 4^\circ$; max. revolutions 10,000 rpm, -30° to $+120^\circ$ C, max. torque 120 Ncm; material: stainless steel bellows, aluminum clamping hubs 	KUP-1010-B	5312983

	Brief description	Type	Part no.
	<ul style="list-style-type: none"> Product segment: Shaft adaptation Product family: Shaft couplings Description: 10 mm / 12 mm; maximum shaft offset: radial +/- 0.25 mm, axial +/- 0.4 mm, angular +/- 4°; max. revolutions 10,000 rpm, -30° to +120 °C, max. torque 120 Ncm; material: stainless steel bellows, aluminum clamping hubs 	KUP-1012-B	5312984
	<ul style="list-style-type: none"> Product segment: Shaft adaptation Product family: Shaft couplings Description: Spring washer coupling, shaft diameter 10 mm / 10 mm, maximum shaft offset, radial ± 0.3 mm, axial ± 0.4 mm, angle ± 2.5°, torsion spring stiffness 30 Nm/rad; material: aluminum flange, glass-fiber reinforced polyamide membrane and hardened steel coupling pin 	KUP-1010-F	5312986
	<ul style="list-style-type: none"> Product segment: Shaft adaptation Product family: Shaft couplings Description: Bar coupling, shaft diameter 8 mm / 10 mm, max. shaft offset: radial ± 0,3 mm, axial ± 0,3 mm, angular ± 3°; max. speed 10.000 rpm, -10° to +80 °C, max. torque: 80 Ncm, material: fiber-glass reinforced polyamide, aluminum hub 	KUP-0810-S	5314178
	<ul style="list-style-type: none"> Product segment: Shaft adaptation Product family: Shaft couplings Description: Spring coupling, shaft diameter 10 mm / 10 mm, maximum shaft offset: radial ± 1.5 mm, axial ± 1.0 mm, angular ± 5°, max. speed 3,000 rpm, -30° to +120 °Celsius, nominal torque 150 Ncm, rotational angle at half nominal torque, direction of rotation right viewed on driving shaft 40°, left viewed on driving shaft 60°, material: spring steel 1.0600 nickel plated, zinc die cast hubs 	KUP-1010-W	5319914
	<ul style="list-style-type: none"> Product segment: Shaft adaptation Product family: Shaft couplings Description: Double loop coupling, shaft diameter 10 mm / 10 mm, Maximum shaft offset: radial +/- 2.5 mm, axial +/- 3 mm, angular +/- 10°; max. speed 3,000 rpm, -30° to +80 °C, max. torque 1.5 Nm; material: polyurethane, galvanized steel flange 	KUP-1010-D	5326703
	<ul style="list-style-type: none"> Product segment: Shaft adaptation Product family: Shaft couplings Description: Double loop coupling, shaft diameter 8 mm / 10 mm, max. shaft offset: radially +/- 0,25 mm, axially +/-0,4 mm, angle +/- 4 degrees;max. speed 10.000 rpm, -30 to +120 degrees Celsius, torsional spring stiffness of 150 Nm/rad 	KUP-0810-D	5326704
	<ul style="list-style-type: none"> Product segment: Shaft adaptation Product family: Shaft couplings Description: Claw coupling, shaft diameter 8 mm / 10 mm, damping element 80 shore blue, maximum shaft offset: radial ± 0.22 mm, axial ± 1 mm angular ± 1.3°, max. speed 19,000 rpm, angle of twist max. 10°, -30 °C to +80 °C, max. torque 800 Ncm, tightening torque of screws: ISO 4029 150 Ncm, material: aluminum flange, damping element: polyurethane 	KUP-0810-J	2128267
	<ul style="list-style-type: none"> Product segment: Shaft adaptation Product family: Shaft couplings Description: Claw coupling, shaft diameter 10 mm / 10 mm, damping element 80 shore blue, maximum shaft offset: radial ± 0.22 mm, axial ± 1 mm angular ± 1.3°, max. speed 19,000 rpm, angle of twist max. 10°, -30 °C to +80 °C, max. torque 800 Ncm, tightening torque of screws: ISO 4029 150 Ncm, material: aluminum flange, damping element: polyurethane 	KUP-1010-J	2127054
	<ul style="list-style-type: none"> Connection type head A: Male connector, M23, 12-pin, straight, A-coded Signal type: HIPERFACE[®], SSI, Incremental Description: HIPERFACE[®], SSI, Incremental, shielded, Head A: male connector, M23, 12-pin, straight, for cable diameter 5.5 mm ... 10.5 mm Head B: - Operating temperature: -40 °C ... +125 °C Connection systems: Solder connection 	STE-2312-G01	2077273
	<ul style="list-style-type: none"> Connection type head A: Male connector, M23, 12-pin, straight, A-coded Signal type: HIPERFACE[®], SSI, Incremental Description: HIPERFACE[®], SSI, Incremental, shielded, M23 female connector with central fixing (for cabinet bushing) Connection systems: Solder connection 	STE-2312-GX	6028548

	Brief description	Type	Part no.
	<ul style="list-style-type: none"> • Connection type head A: Male connector, M12, 8-pin, straight, A-coded • Signal type: Incremental • Cable: CAT5, CAT5e • Description: Incremental, shielded, Head A: male connector, M12, 8-pin, straight, A coded, shielded, for cable diameter 4 mm ... 8 mm Head B: - Operating temperature: -40 °C ... +85 °C • Connection systems: IDC quick connection • Permitted cross-section: 0.14 mm² ... 0.34 mm² 	STE-1208-GA01	6044892

SICK AT A GLANCE

SICK is one of the leading manufacturers of intelligent sensors and sensor solutions for industrial applications. A unique range of products and services creates the perfect basis for controlling processes securely and efficiently, protecting individuals from accidents and preventing damage to the environment.

We have extensive experience in a wide range of industries and understand their processes and requirements. With intelligent sensors, we can deliver exactly what our customers need. In application centers in Europe, Asia and North America, system solutions are tested and optimized in accordance with customer specifications. All this makes us a reliable supplier and development partner.

Comprehensive services complete our offering: SICK LifeTime Services provide support throughout the machine life cycle and ensure safety and productivity.

For us, that is “Sensor Intelligence.”

WORLDWIDE PRESENCE:

Contacts and other locations –www.sick.com