



KTL180-MM4P41ZZZZZ

KTL180

CONTRAST SENSORS

SICK
Sensor Intelligence.



Illustration may differ



Ordering information

Type	Part no.
KTL180-MM4P41ZZZZZ	6068616

Other models and accessories → www.sick.com/KTL180

Detailed technical data

Features

Special applications	-
Device type	Base unit
Indication	Display
Display	LED status display / 2x 4-character digital dual displays, Set value (green indicator) and actual value (red indicator) are displayed simultaneously, display of parameters
Dimensions (W x H x D)	10.5 mm x 33.2 mm x 71.9 mm
Sensing range	0 mm ... 30 mm, Proximity system ¹⁾
Sensing distance	≤ 30 mm ²⁾
Housing design (light emission)	For fiber-optic
Light source	LED, white ³⁾
Angle of dispersion	Approx. 65° ⁴⁾
Wave length	400 nm ... 750 nm
Teach-in mode	1-point teach-in, 2-point teach-in, teach-in dynamic
Delay time	Adjustable
Special features	Multi-function input, base unit for BUS mode
Delivery status	Teach-in dynamic
Parameter presets	None

¹⁾ Objects to be sensed with 90% reflectivity (based on DIN 5033 white standard). Sensing range depends on fiber-optic cable.

²⁾ Depends on the fiber used.

³⁾ Average service life: 100,000 h at T_U = +25 °C.

⁴⁾ See LL3 fiber-optic data.

Mechanics/electronics

Supply voltage	12 V DC ... 24 V DC ¹⁾
Ripple	≤ 10 % ²⁾
Current consumption	≥ 50 mA (at 24 V)
Switching frequency	31.2 kHz
Response time	16 μs
Jitter	8 μs
Switching output	PNP
Switching mode	Light/dark switching
Output current I_{max.}	100 mA ³⁾
Input, blanking input (AT)	Blanked: U = 6.5 V ... < U _v : free-running: U < 5.5 V ⁴⁾
Input, light/dark (L/D)	Light: U < 6.5 V: dark: U = 5.5 V ... < U _V ⁴⁾
Retention time (ET)	25 ms, non-volatile memory
Connection type	Male connector M8, 4-pin
Protection class	III
Circuit protection	U _v connections, reverse polarity protected In-/outputs short-circuit protected Interference pulse suppression Outputs overcurrent and short-circuit protected
Enclosure rating	IP50
Weight	25 g
Housing material	Plastic, VISTAL®

1) +- 10%.

2) May not exceed or fall below U_v tolerances.

3) Total current of all Outputs.

4) Minimum pulse 300 μs.

Ambient data

Ambient operating temperature	-25 °C ... +55 °C
Ambient temperature, storage	-40 °C ... +70 °C
Shock load	IEC 60068-2-27
UL File No.	EN 60947-5-2

Classifications

ECl@ss 5.0	27270906
ECl@ss 5.1.4	27270906
ECl@ss 6.0	27270906
ECl@ss 6.2	27270906
ECl@ss 7.0	27270906
ECl@ss 8.0	27270906
ECl@ss 8.1	27270906
ECl@ss 9.0	27270906
ECl@ss 10.0	27270906
ECl@ss 11.0	27270906

ETIM 5.0	EC001820
ETIM 6.0	EC001820
ETIM 7.0	EC001820
ETIM 8.0	EC001820
UNSPSC 16.0901	39121528

Dimensional drawing (Dimensions in mm (inch))

Bus type

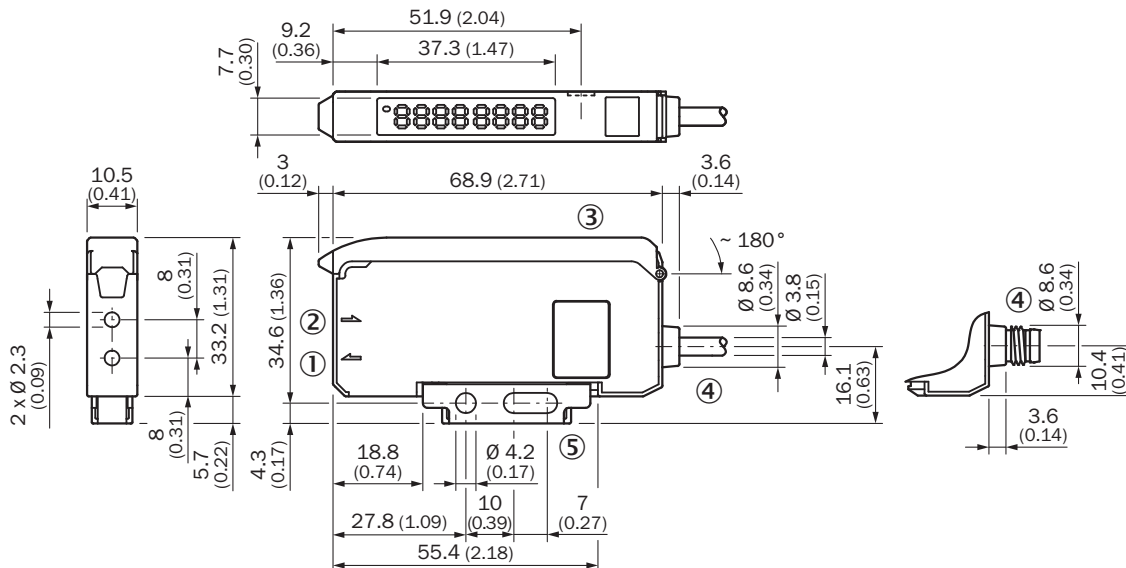

- ① Sender LED, installation of LL3 fibre-optic cable (sender fibre)
- ② Receiver, installation of LL3 fibre optic cable (receiver fibre)
- ③ Protective hood opens approx. 180°
- ④ Connection
- ⑤ Mounting bracket, included with delivery

Adjustments

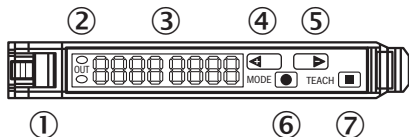

- ① Locking the fiber-optic cables
- ② LED indicator orange, lights up when switching output is active
- ③ Numeric display 2 x 4-digit; green: switching threshold, operating mode; red: actual value, Teach-in and function parameter
- ④ Step pushbutton > (manual switching threshold: higher/next function parameter)
- ⑤ Step pushbutton < (manual switching threshold: lower/previous function parameter)
- ⑥ Mode/Enter-button
- ⑦ Teach-in button

Connection diagram

Cd-380

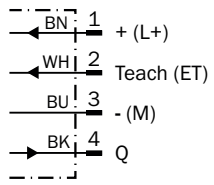

Sensing distance

LL3-DZ01

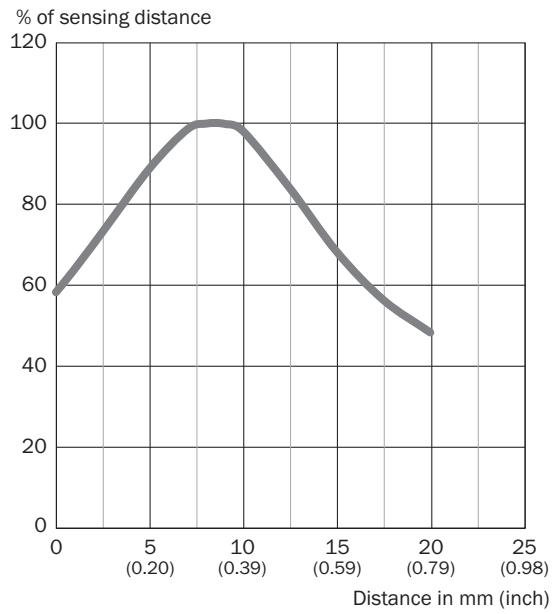

LL3-DM02 (LL3-DA09)

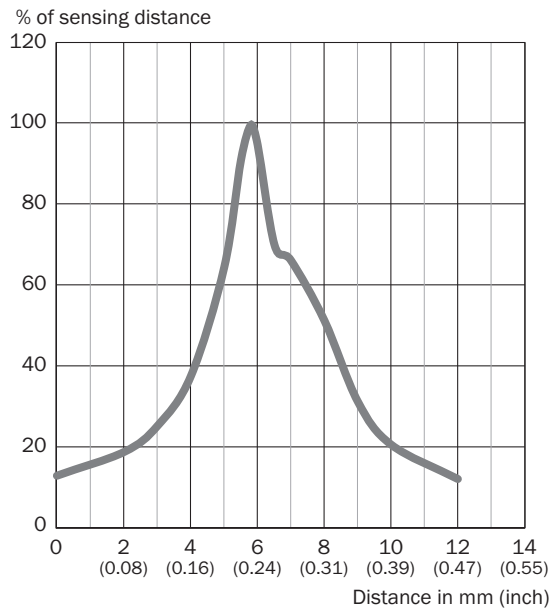

LL3-DM02 (LL3-DA06)

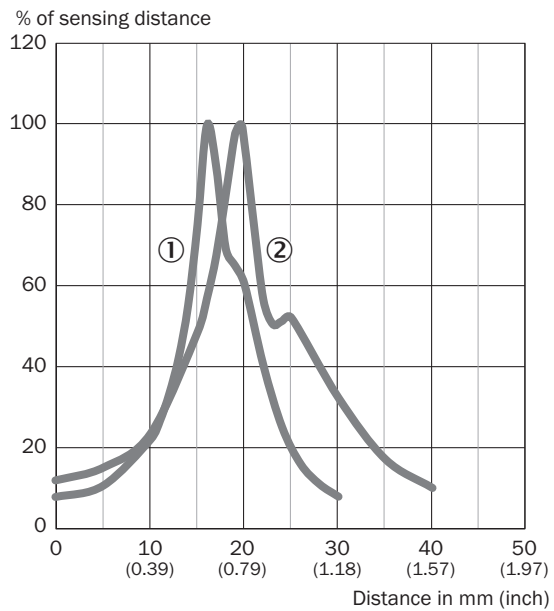

- ① Thread with 3 mm distance
- ② Thread screwed flush with the nut

LL3-DM02 (LL3-DA06)

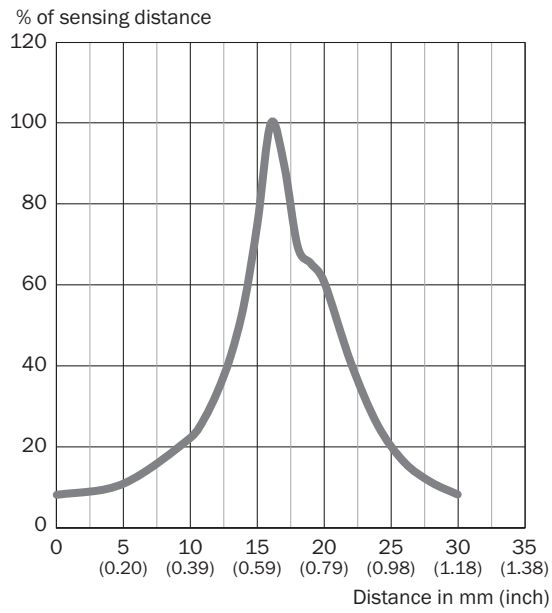

LL3-DC38

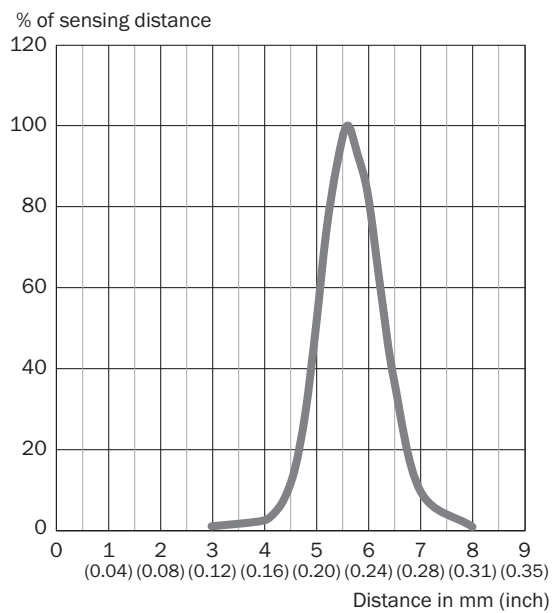

LL3-DB09, LL3-DK04, LL3-DY01

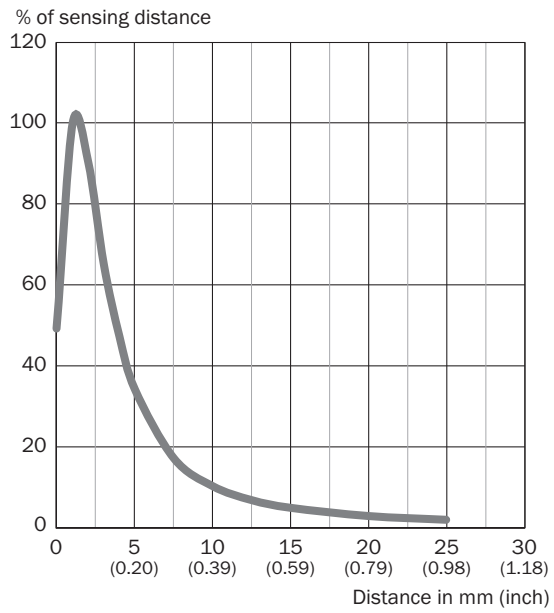

LL3-DB01, LL3-DB04, LL3DM02

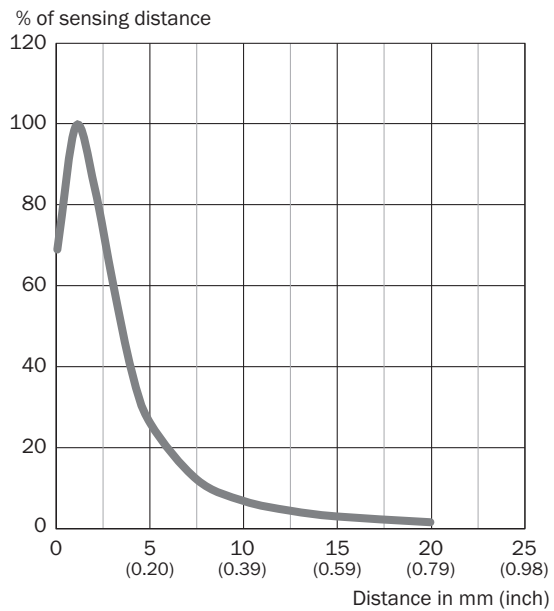



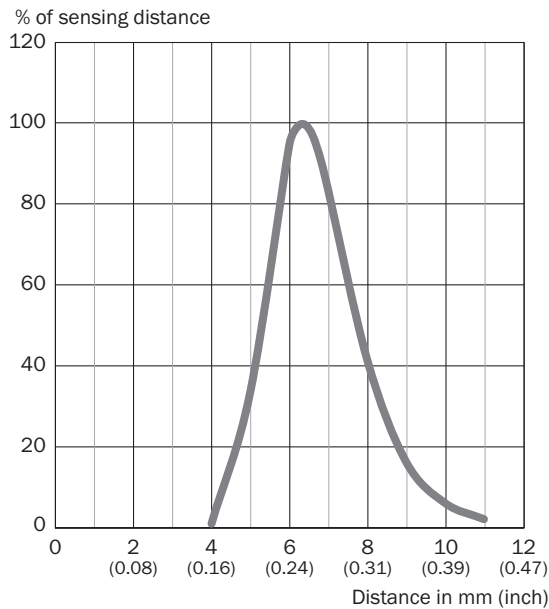





LL3-DC09



Recommended accessories

Other models and accessories → www.sick.com/KTL180

	Brief description	Type	Part no.
Fieldbus modules			
	EtherCAT coupler for WLL180T, KTL180 and AOD1. %Features: EtherCAT; transmission rates of up to 100 Mbaud; M12 EtherCAT connection; M8 voltage supply connection, 4-pin; full read/write functionality for the process and service data of the connected sensors. See operating instructions for additional information and technical details	WI180C-EC	6068089
	PROFINET coupler for WLL180T, KTL180 and AOD1. %Features: PROFINET IRT; transmission rates 10 Mbaud – 100 Mbaud; M12 PROFINET connection; M8 voltage supply connection, 4-pin; full read/write functionality for the process and service data of the connected sensors. See operating instructions for additional information and technical details	WI180C-PN	6068088
	IO-Link Smart Sensor Gateway for WLL180T, KTL180 and AOD1; Features: IO-Link; COM3; M8 connection, 4-pin; full read/write functionality for the process and service data of the connected sensors. See operating instructions for additional information and technical details	WI180C-IOA00	6071650
	Fiber optic cable adaptor kit	Fiber Optic Adaptor Kit	2062854
Mounting brackets and plates			
	Mounting bracket, steel, zinc coated, without mounting hardware	BEF-WLL180	5325812
Other mounting accessories			
	Rail end piece for block mounting, stainless steel, mounting hardware included	BEF-EB01-W190	5313011

	Brief description	Type	Part no.
	Cutter for fibers, supplied with LL3	FC	5304141
Plug connectors and cables			
	Head A: female connector, M8, 4-pin, straight, A-coded Head B: Flying leads Cable: Sensor/actuator cable, PVC, unshielded, 5 m	YF8U14-050VA3XLEAX	2095889
	Head A: male connector, M8, 4-pin, straight Cable: unshielded	STE-0804-G	6037323
Fibers			
	LL3-DA06	LL3-DA06	5326468
	LL3-DA09	LL3-DA09	5334040
	LL3-DB01	LL3-DB01	5308074
	LL3-DB04	LL3-DB04	5325990
	LL3-DB09	LL3-DB09	5325991
	LL3-DC09	LL3-DC09	5326028
	LL3-DC38	LL3-DC38	5322472
	LL3-DK04	LL3-DK04	5313020
	LL3-DM02	LL3-DM02	5308077
	LL3-DV01	LL3-DV01	5308088
	LL3-DY01	LL3-DY01	5308093
	LL3-DZ01	LL3-DZ01	5326013
	LL3-TS40	LL3-TS40	5323971

SICK AT A GLANCE

SICK is one of the leading manufacturers of intelligent sensors and sensor solutions for industrial applications. A unique range of products and services creates the perfect basis for controlling processes securely and efficiently, protecting individuals from accidents and preventing damage to the environment.

We have extensive experience in a wide range of industries and understand their processes and requirements. With intelligent sensors, we can deliver exactly what our customers need. In application centers in Europe, Asia and North America, system solutions are tested and optimized in accordance with customer specifications. All this makes us a reliable supplier and development partner.

Comprehensive services complete our offering: SICK LifeTime Services provide support throughout the machine life cycle and ensure safety and productivity.

For us, that is “Sensor Intelligence.”

WORLDWIDE PRESENCE:

Contacts and other locations –www.sick.com