



WT27L-2F430A01

W27

COMPACT PHOTOELECTRIC SENSORS

SICK
Sensor Intelligence.



Ordering information

Type	Part no.
WT27L-2F430A01	1019512

Other models and accessories → www.sick.com/W27

Illustration may differ



Detailed technical data

Features

Functional principle	Photoelectric proximity sensor
Functional principle detail	Background suppression
Dimensions (W x H x D)	24.6 mm x 80 mm x 53.5 mm
Housing design (light emission)	Rectangular
Sensing range max.	100 mm ... 800 mm ¹⁾
Sensing range	100 mm ... 800 mm
Type of light	Visible red light
Light source	Laser ²⁾
Light spot size (distance)	Ø 2 mm (400 mm)
Wave length	650 nm
Laser class	2 (EN 60825-1), low power. Eyes are normally protected by averting reaction and eyelid closing reflex.
Adjustment	Potentiometer
Special applications	Detecting small objects

¹⁾ Object with 90% remission (based on standard white, DIN 5033).

²⁾ Average service life: 50,000 h at T_U = +25 °C.

Mechanics/electronics

Supply voltage U_B	10 V DC ... 30 V DC ¹⁾
Ripple	$\pm 5\%$ ²⁾
Current consumption	35 mA ³⁾
Switching output	PNP
Output function	Complementary
Switching mode	Light/dark switching
Output current I_{max}	≤ 100 mA
Response time	< 500 μ s ⁴⁾
Switching frequency	1,000 Hz ⁵⁾
Connection type	Male connector M12, 4-pin
Circuit protection	A ⁶⁾ C ⁷⁾ D ⁸⁾
Protection class	II ⁹⁾
Weight	100 g
Housing material	Plastic, ABS
Enclosure rating	IP67
Ambient operating temperature	-10 °C ... +45 °C
Ambient temperature, storage	-10 °C ... +75 °C
UL File No.	NRKH.E181493 & NRKH7.E181493

¹⁾ Limit values when operated in short-circuit protected network: max. 8 A.

²⁾ May not exceed or fall below U_V tolerances.

³⁾ Without load.

⁴⁾ Signal transit time with resistive load.

⁵⁾ With light/dark ratio 1:1.

⁶⁾ A = V_S connections reverse-polarity protected.

⁷⁾ C = interference suppression.

⁸⁾ D = outputs overcurrent and short-circuit protected.

⁹⁾ Reference voltage: 50 V DC.

Classifications

ECLASS 5.0	27270904
ECLASS 5.1.4	27270904
ECLASS 6.0	27270904
ECLASS 6.2	27270904
ECLASS 7.0	27270904
ECLASS 8.0	27270904
ECLASS 8.1	27270904
ECLASS 9.0	27270904
ECLASS 10.0	27270904
ECLASS 11.0	27270904
ECLASS 12.0	27270903
ETIM 5.0	EC002719

ETIM 6.0	EC002719
ETIM 7.0	EC002719
ETIM 8.0	EC002719
UNSPSC 16.0901	39121528

Adjustments

Potentiometer

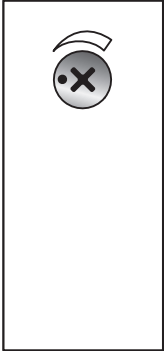

Connection type

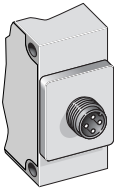

Connection diagram

Cd-083

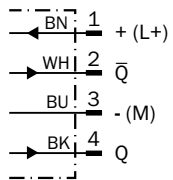

Characteristic curve

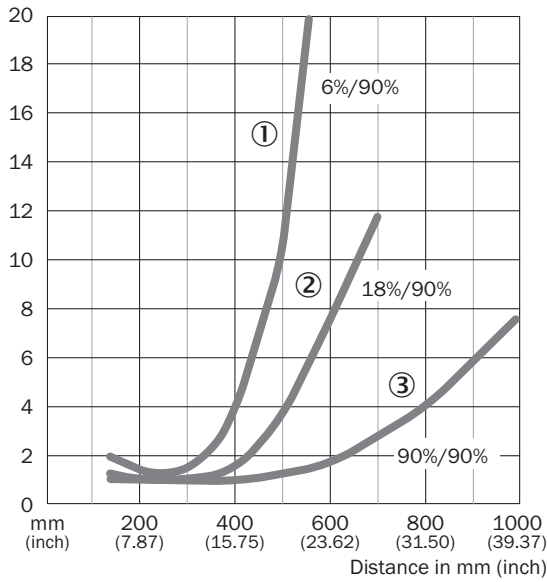

Sensing range diagram

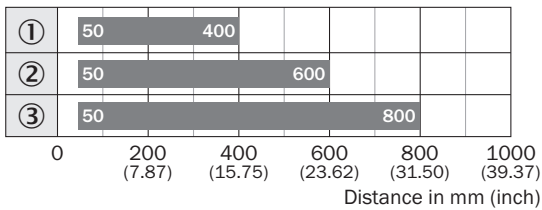

■ Sensing range



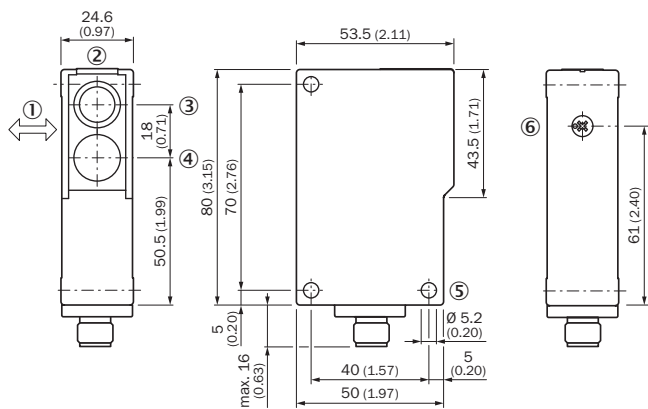

Dimensional drawing (Dimensions in mm (inch))



- ① Standard direction
- ② LED signal strength indicator
- ③ Optical axis, sender
- ④ Optical axis, receiver
- ⑤ Mounting hole, Ø 5.2 mm
- ⑥ Sensing range adjustment: potentiometer

Recommended accessories

Other models and accessories → www.sick.com/W27

	Brief description	Type	Part no.
Mounting brackets and plates			
	Aluminum, Including mounting material (sensor) and mounting material (bracket)	BEF-AP-W12	2127742
Plug connectors and cables			
		YF2A14-050VB3XLEAX	2096235
		STE-1204-G	6009932

SICK AT A GLANCE

SICK is one of the leading manufacturers of intelligent sensors and sensor solutions for industrial applications. A unique range of products and services creates the perfect basis for controlling processes securely and efficiently, protecting individuals from accidents and preventing damage to the environment.

We have extensive experience in a wide range of industries and understand their processes and requirements. With intelligent sensors, we can deliver exactly what our customers need. In application centers in Europe, Asia and North America, system solutions are tested and optimized in accordance with customer specifications. All this makes us a reliable supplier and development partner.

Comprehensive services complete our offering: SICK LifeTime Services provide support throughout the machine life cycle and ensure safety and productivity.

For us, that is “Sensor Intelligence.”

WORLDWIDE PRESENCE:

Contacts and other locations –www.sick.com