



# DBS36E-S3AL01000

DBS36/50

INCREMENTAL ENCODERS

**SICK**  
Sensor Intelligence.

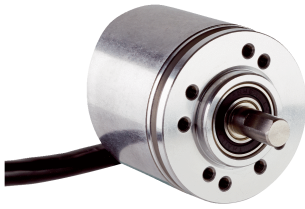

Illustration may differ



### Ordering information

Type	Part no.
DBS36E-S3AL01000	1064667

Other models and accessories → [www.sick.com/DBS36\\_50](http://www.sick.com/DBS36_50)

### Detailed technical data

#### Safety-related parameters

<b>MTTF<sub>D</sub> (mean time to dangerous failure)</b>	600 years (EN ISO 13849-1) <sup>1)</sup>
----------------------------------------------------------	------------------------------------------

<sup>1)</sup> This product is a standard product and does not constitute a safety component as defined in the Machinery Directive. Calculation based on nominal load of components, average ambient temperature 40 °C, frequency of use 8760 h/a. All electronic failures are considered hazardous. For more information, see document no. 8015532.

#### Performance

<b>Pulses per revolution</b>	1,000
<b>Measuring step</b>	90°, electric/pulses per revolution
<b>Measuring step deviation</b>	± 18° / pulses per revolution
<b>Error limits</b>	± 54° / pulses per revolution
<b>Duty cycle</b>	≤ 0.5 ± 5 %

#### Interfaces

<b>Communication interface</b>	Incremental
<b>Communication Interface detail</b>	TTL / RS-422
<b>Number of signal channels</b>	6-channel
<b>Initialization time</b>	< 3 ms
<b>Output frequency</b>	≤ 300 kHz
<b>Load current</b>	≤ 30 mA
<b>Operating current</b>	≤ 50 mA (without load)

#### Electronics

<b>Connection type</b>	Cable, 8-wire, universal, 3 m
<b>Supply voltage</b>	4.5 ... 5.5 V
<b>Reference signal, number</b>	1
<b>Reference signal, position</b>	90°, electric, logically gated with A and B
<b>Short-circuit protection of the outputs</b>	✓ <sup>1)</sup>

<sup>1)</sup> The short-circuit rating is only given if Us and GND are connected correctly.

## Mechanics

<b>Mechanical design</b>	Solid shaft, face mount flange
<b>Shaft diameter</b>	6 mm With face
<b>Shaft length</b>	12 mm
<b>Weight</b>	+ 150 g (with connecting cable)
<b>Shaft material</b>	Stainless steel
<b>Flange material</b>	Aluminum
<b>Housing material</b>	Aluminum
<b>Material, cable</b>	PVC
<b>Start up torque</b>	+ 0.5 Ncm (+20 °C)
<b>Operating torque</b>	0.4 Ncm (+20 °C)
<b>Permissible shaft loading</b>	40 N (radial) <sup>1)</sup> 20 N (axial)
<b>Operating speed</b>	6,000 min <sup>-1</sup> <sup>2)</sup>
<b>Maximum operating speed</b>	≤ 8,000 min <sup>-1</sup> <sup>3)</sup>
<b>Moment of inertia of the rotor</b>	0.6 gcm <sup>2</sup>
<b>Bearing lifetime</b>	2 x 10 <sup>9</sup> revolutions
<b>Angular acceleration</b>	≤ 500,000 rad/s <sup>2</sup>

<sup>1)</sup> Higher values are possible using limited bearing life.

<sup>2)</sup> Allow for self-heating of 3.3 K per 1,000 rpm when designing the operating temperature range.

<sup>3)</sup> No permanent operation. Decreasing signal quality.

## Ambient data

<b>EMC</b>	According to EN 61000-6-2 and EN 61000-6-3 (class A)
<b>Enclosure rating</b>	IP65
<b>Permissible relative humidity</b>	90 % (Condensation not permitted)
<b>Operating temperature range</b>	-20 °C ... +85 °C, -35 °C ... +95 °C on request
<b>Storage temperature range</b>	-40 °C ... +100 °C, without package
<b>Resistance to shocks</b>	100 g, 6 ms (EN 60068-2-27)
<b>Resistance to vibration</b>	20 g, 10 Hz ... 2,000 Hz (EN 60068-2-6)

## Classifications

<b>ECLASS 5.0</b>	27270501
<b>ECLASS 5.1.4</b>	27270501
<b>ECLASS 6.0</b>	27270590
<b>ECLASS 6.2</b>	27270590
<b>ECLASS 7.0</b>	27270501
<b>ECLASS 8.0</b>	27270501
<b>ECLASS 8.1</b>	27270501
<b>ECLASS 9.0</b>	27270501
<b>ECLASS 10.0</b>	27270501
<b>ECLASS 11.0</b>	27270501
<b>ECLASS 12.0</b>	27270501

<b>ETIM 5.0</b>	EC001486
<b>ETIM 6.0</b>	EC001486
<b>ETIM 7.0</b>	EC001486
<b>ETIM 8.0</b>	EC001486
<b>UNSPSC 16.0901</b>	41112113

### Dimensional drawing (Dimensions in mm (inch))

Solid shaft, face mount flange, shaft 6 mm x 12 mm, type 0 flange design hole pattern

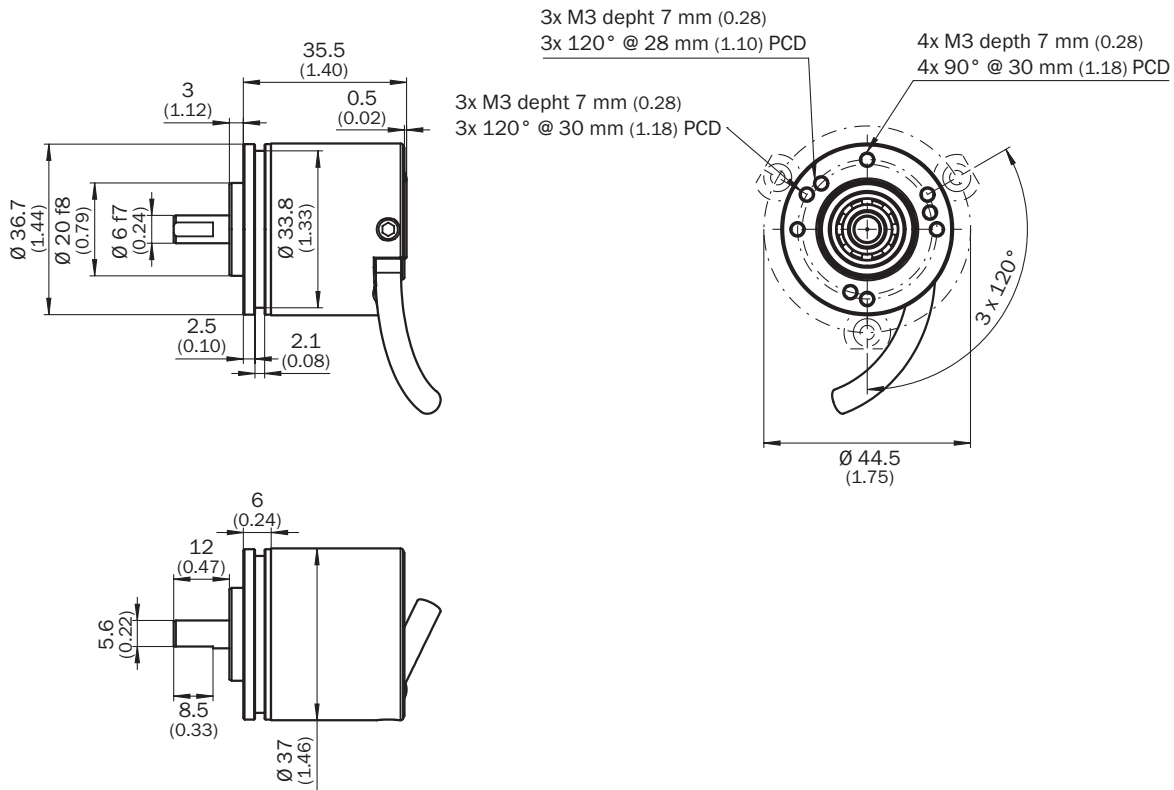

### PIN assignment

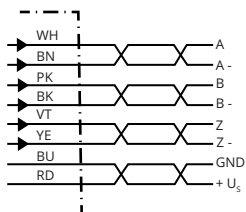

Wire colors (cable connection)	Male connector M12, 8-pin	Male connector M23, 12-pin	TTL/HTL 6-channel signal	Explanation
Brown	1	6	A-	Signal wire
White	2	5	A	Signal wire
Black	3	1	B-	Signal wire

Wire colors (cable connection)	Male connector M12, 8-pin	Male connector M23, 12-pin	TTL/HTL 6-channel signal	Explanation
Pink	4	8	B	Signal wire
Yellow	5	4	Z-	Signal wire
Purple	6	3	Z	Signal wire
Blue	7	10	GND	Ground connection
Red	8	12	+U <sub>s</sub>	Supply voltage
-	-	9	Not assigned	Not assigned
-	-	2	Not assigned	Not assigned
-	-	11	Not assigned	Not assigned
-	-	7	Not assigned	Not assigned

### Diagrams

Signal outputs for electrical interfaces TTL and HTL

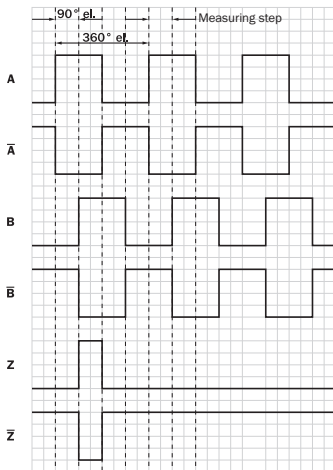











Cw with view on the encoder shaft in direction "A", compare dimensional drawing.









① Interfaces G, P, R only for channels A, B, Z.



Supply voltage	Output
4.5 V...5.5 V	TTL/RS422
7 V...30 V	TTL/RS422
7 V...30 V	HTL/Push Pull
7 V...27 V	HTL/push pull, 3 channel
4.5 V...5.5 V	Open Collector NPN, 3 channel
4.5 V...30 V	Open Collector NPN, 3 channel

### Recommended accessories

Other models and accessories → [www.sick.com/DBS36\\_50](http://www.sick.com/DBS36_50)

	Brief description	Type	Part no.
Others			
	<ul style="list-style-type: none"> <li>• <b>Connection type head A:</b> Flying leads</li> <li>• <b>Connection type head B:</b> Flying leads</li> <li>• <b>Signal type:</b> SSI, Incremental, HIPERFACE®</li> <li>• <b>Items supplied:</b> By the meter</li> <li>• <b>Cable:</b> 8-wire, PUR, halogen-free</li> <li>• <b>Description:</b> SSI, Incremental, HIPERFACE®, shielded</li> </ul>	LTG-2308-MWENC	6027529
	<ul style="list-style-type: none"> <li>• <b>Connection type head A:</b> Flying leads</li> <li>• <b>Connection type head B:</b> Flying leads</li> <li>• <b>Signal type:</b> SSI, Incremental</li> <li>• <b>Items supplied:</b> By the meter</li> <li>• <b>Cable:</b> 11-wire, PUR</li> <li>• <b>Description:</b> SSI, Incremental, shielded</li> </ul>	LTG-2411-MW	6027530
	<ul style="list-style-type: none"> <li>• <b>Connection type head A:</b> Flying leads</li> <li>• <b>Connection type head B:</b> Flying leads</li> <li>• <b>Signal type:</b> SSI, Incremental</li> <li>• <b>Items supplied:</b> By the meter</li> <li>• <b>Cable:</b> 12-wire, PUR, halogen-free</li> <li>• <b>Description:</b> SSI, Incremental, shielded</li> </ul>	LTG-2512-MW	6027531
	<ul style="list-style-type: none"> <li>• <b>Connection type head A:</b> Flying leads</li> <li>• <b>Connection type head B:</b> Flying leads</li> <li>• <b>Signal type:</b> SSI, TTL, HTL, Incremental</li> <li>• <b>Items supplied:</b> By the meter</li> <li>• <b>Cable:</b> 12-wire, UV and saltwater-resistant, PUR, halogen-free</li> <li>• <b>Description:</b> SSI, TTL, HTL, Incremental, shielded, Head A: cable Head B: cable Cable: suitable for drag chain, PUR, halogen-free, shielded, UV and saltwater resistant, 4 x 2 x 0.25 mm<sup>2</sup> + 2 x 0.5 mm<sup>2</sup> + 2 x 0.14 mm<sup>2</sup>, Ø 7.8 mm</li> </ul>	LTG-2612-MW	6028516
	<ul style="list-style-type: none"> <li>• <b>Product family:</b> Flanges and nozzles</li> <li>• <b>Description:</b> Flange adapter, adapts face mount flange with 20 mm centering collar to 33 mm servo flange</li> <li>• <b>Material:</b> Aluminum</li> <li>• <b>Details:</b> Aluminum</li> </ul>	BEF-FA-020-033	2066312
	<ul style="list-style-type: none"> <li>• <b>Product segment:</b> Measuring wheels and measuring wheel mechanics</li> <li>• <b>Product family:</b> Measuring wheels</li> <li>• <b>Description:</b> Aluminium measuring wheel with O-ring (NBR70) for 6 mm solid shaft, circumference 200 mm</li> </ul>	BEF-MR006020R	2055222
	<ul style="list-style-type: none"> <li>• <b>Product segment:</b> Measuring wheels and measuring wheel mechanics</li> <li>• <b>Product family:</b> Measuring wheels</li> <li>• <b>Description:</b> Measuring wheel with O-ring (NBR70) for 6 mm solid shaft, circumference 300 mm</li> </ul>	BEF-MR006030R	2055634
	<ul style="list-style-type: none"> <li>• <b>Product segment:</b> Measuring wheels and measuring wheel mechanics</li> <li>• <b>Product family:</b> Measuring wheels</li> <li>• <b>Description:</b> Aluminium measuring wheel with O-ring (NBR70) for 6 mm solid shaft, circumference 500 mm</li> </ul>	BEF-MR006050R	2055225
	<ul style="list-style-type: none"> <li>• <b>Product segment:</b> Measuring wheels and measuring wheel mechanics</li> <li>• <b>Product family:</b> Measuring wheels</li> <li>• <b>Description:</b> Aluminum measuring wheel with cross-knurled surface for 6 mm solid shaft, circumference 200 mm</li> </ul>	BEF-MR06200AK	4084745
	<ul style="list-style-type: none"> <li>• <b>Product segment:</b> Measuring wheels and measuring wheel mechanics</li> <li>• <b>Product family:</b> Measuring wheels</li> <li>• <b>Description:</b> Aluminum measuring wheel with smooth polyurethane surface for 6 mm solid shaft, circumference 200 mm</li> </ul>	BEF-MR06200AP	4084746
	<ul style="list-style-type: none"> <li>• <b>Product segment:</b> Measuring wheels and measuring wheel mechanics</li> <li>• <b>Product family:</b> Measuring wheels</li> <li>• <b>Description:</b> Aluminum measuring wheel with ridged polyurethane surface for 6 mm solid shaft, circumference 200 mm</li> </ul>	BEF-MR06200APG	4084748

	Brief description	Type	Part no.
	<ul style="list-style-type: none"> <li><b>Product segment:</b> Measuring wheels and measuring wheel mechanics</li> <li><b>Product family:</b> Measuring wheels</li> <li><b>Description:</b> Aluminum measuring wheel with studded polyurethane surface for 6 mm solid shaft, circumference 200 mm</li> </ul>	BEF-MR06200APN	4084747
	BEF-OR-053-040	BEF-OR-053-040	2064061
	BEF-OR-083-050	BEF-OR-083-050	2064076
	BEF-OR-145-050	BEF-OR-145-050	2064074
	<ul style="list-style-type: none"> <li><b>Product segment:</b> Shaft adaptation</li> <li><b>Product family:</b> Shaft couplings</li> <li><b>Description:</b> Bellows coupling, shaft diameter 6 mm / 6 mm, maximum shaft offset: radial <math>\pm 0.25</math> mm, axial <math>\pm 0.4</math> mm, angular <math>\pm 4^\circ</math>; max. speed 10,000 rpm, <math>-30^\circ</math> °C to <math>+120^\circ</math> °C, max. torque 120 Ncm; material: stainless steel bellows, aluminum hub</li> </ul>	KUP-0606-B	5312981
	<ul style="list-style-type: none"> <li><b>Product segment:</b> Shaft adaptation</li> <li><b>Product family:</b> Shaft couplings</li> <li><b>Description:</b> Cross-slotted coupling, shaft diameter 6 mm / 6 mm, maximum shaft offset: radial <math>\pm 0.3</math> mm, axial <math>\pm 0.2</math> mm, angle <math>\pm 3^\circ</math>; max. speed 10,000 rpm, <math>-10^\circ</math> to <math>+80^\circ</math> °C, max. torque 80 Ncm; material: fiber-glass reinforced polyamide, aluminum hub</li> </ul>	KUP-0606-S	2056406
	<ul style="list-style-type: none"> <li><b>Product segment:</b> Shaft adaptation</li> <li><b>Product family:</b> Shaft couplings</li> <li><b>Description:</b> Bar coupling, shaft diameter 6 mm / 8 mm, maximum shaft offset radial <math>\pm 0.3</math> mm, axial <math>\pm 0.2</math> mm, angle <math>\pm 3^\circ</math>, max. speed 10,000 rpm, torsion spring rigidity 38 Nm/wheel; material: fiber-glass reinforced polyamide, aluminum hub</li> </ul>	KUP-0608-S	5314179
	<ul style="list-style-type: none"> <li><b>Product segment:</b> Shaft adaptation</li> <li><b>Product family:</b> Shaft couplings</li> <li><b>Description:</b> Bellows coupling, shaft diameter 6 mm / 10 mm, maximum shaft offset: radial <math>\pm 0.25</math> mm, axial <math>\pm 0.4</math> mm, angular <math>\pm 4^\circ</math>; max. speed 10,000 rpm, <math>-30^\circ</math> °C to <math>+120^\circ</math> °C, max. torque 120 Ncm; material: stainless steel bellows, aluminum hub</li> </ul>	KUP-0610-B	5312982
	<ul style="list-style-type: none"> <li><b>Product segment:</b> Shaft adaptation</li> <li><b>Product family:</b> Shaft couplings</li> <li><b>Description:</b> Double loop coupling, shaft diameter 6 mm / 10 mm, max. shaft offset: radially <math>\pm 2.5</math> mm, axially <math>\pm 3</math> mm, angle <math>\pm 10</math> degrees; max. speed 3.000 rpm, <math>-30</math> to <math>+80</math> degrees Celsius, torsional spring stiffness of 25 Nm/rad</li> </ul>	KUP-0610-D	5326697
	<ul style="list-style-type: none"> <li><b>Product segment:</b> Shaft adaptation</li> <li><b>Product family:</b> Shaft couplings</li> <li><b>Description:</b> Spring washer coupling, shaft diameter 6 mm / 10 mm, Maximum shaft offset: radial <math>\pm 0.3</math> mm, axial <math>\pm 0.4</math> mm, angular <math>\pm 2.5^\circ</math>; max. speed 12,000 rpm, <math>-10^\circ</math> to <math>+80^\circ</math> °C, max. torque 60 Ncm; material: aluminum flange, glass fiber-reinforced polyamide membrane and hardened steel coupling pin</li> </ul>	KUP-0610-F	5312985
	<ul style="list-style-type: none"> <li><b>Product segment:</b> Shaft adaptation</li> <li><b>Product family:</b> Shaft couplings</li> <li><b>Description:</b> Bar coupling, shaft diameter 6 mm / 10 mm, max. shaft offset: radial <math>\pm 0.3</math> mm, axial <math>\pm 0.3</math> mm, angular <math>\pm 3^\circ</math>; max. speed 10.000 rpm, <math>-10^\circ</math> to <math>+80^\circ</math> °C, max. torque: 80 Ncm, material: fiber-glass reinforced polyamide, aluminum hub</li> </ul>	KUP-0610-S	2056407
	<ul style="list-style-type: none"> <li><b>Product segment:</b> Shaft adaptation</li> <li><b>Product family:</b> Shaft couplings</li> <li><b>Description:</b> Claw coupling, shaft diameter 6 mm / 10 mm, damping element 80 shore blue, maximum shaft offset: radial <math>\pm 0.22</math> mm, axial <math>\pm 1</math> mm angular <math>\pm 1.3^\circ</math>, max. speed 19,000 rpm, angle of twist max. <math>10^\circ</math>, <math>-30^\circ</math> °C to <math>+80^\circ</math> °C, max. torque 800 Ncm, tightening torque of screws: ISO 4029 150 Ncm, material: aluminum flange, damping element: polyurethane</li> </ul>	KUP-0610-J	2127056
	<ul style="list-style-type: none"> <li><b>Connection type head A:</b> Male connector, M12, 8-pin, straight, A-coded</li> <li><b>Signal type:</b> Incremental</li> <li><b>Cable:</b> CAT5, CAT5e</li> <li><b>Description:</b> Incremental, shielded, Head A: male connector, M12, 8-pin, straight, A coded, shielded, for cable diameter 4 mm ... 8 mm Head B: - Operating temperature: <math>-40^\circ</math> °C ... <math>+85^\circ</math> °C</li> <li><b>Connection systems:</b> IDC quick connection</li> <li><b>Permitted cross-section:</b> 0.14 mm<sup>2</sup> ... 0.34 mm<sup>2</sup></li> </ul>	STE-1208-GA01	6044892

	Brief description	Type	Part no.
	<ul style="list-style-type: none"> <li>• <b>Connection type head A:</b> Male connector, M23, 12-pin, straight, A-coded</li> <li>• <b>Signal type:</b> HIPERFACE<sup>®</sup>, SSI, Incremental</li> <li>• <b>Description:</b> HIPERFACE<sup>®</sup>, SSI, Incremental, shielded, M23 female connector with central fixing ( for cabinet bushing )</li> <li>• <b>Connection systems:</b> Solder connection</li> </ul>	STE-2312-GX	6028548
	<ul style="list-style-type: none"> <li>• <b>Connection type head A:</b> Male connector, M23, 12-pin, straight, A-coded</li> <li>• <b>Signal type:</b> HIPERFACE<sup>®</sup>, SSI, Incremental</li> <li>• <b>Description:</b> HIPERFACE<sup>®</sup>, SSI, Incremental, shielded, Head A: male connector, M23, 12-pin, straight, for cable diameter 5.5 mm ... 10.5 mm Head B: - Operating temperature: -40 °C ... +125 °C</li> <li>• <b>Connection systems:</b> Solder connection</li> </ul>	STE-2312-G01	2077273



## SICK AT A GLANCE

SICK is one of the leading manufacturers of intelligent sensors and sensor solutions for industrial applications. A unique range of products and services creates the perfect basis for controlling processes securely and efficiently, protecting individuals from accidents and preventing damage to the environment.

We have extensive experience in a wide range of industries and understand their processes and requirements. With intelligent sensors, we can deliver exactly what our customers need. In application centers in Europe, Asia and North America, system solutions are tested and optimized in accordance with customer specifications. All this makes us a reliable supplier and development partner.

Comprehensive services complete our offering: SICK LifeTime Services provide support throughout the machine life cycle and ensure safety and productivity.

For us, that is “Sensor Intelligence.”

## WORLDWIDE PRESENCE:

Contacts and other locations –[www.sick.com](http://www.sick.com)