



MLSE-0200C2NUA

MLS

MAGNETIC SENSORS

SICK
Sensor Intelligence.



Ordering information

Type	Part no.
MLSE-0200C2NUA	1113030

Other models and accessories → www.sick.com/MLS



Detailed technical data

Features

Detection range typ.	200 mm
Operating height	10 mm ... 70 mm
Electrical wiring	DC 4-wire
Enclosure rating	IP65, IP67, IP68 ¹⁾

¹⁾ According to EN 60529.

Mechanics/electronics

Supply voltage	9 V DC ... 30 V DC
Terminal resistor	No internal terminator
Protection class	III
Power consumption	600 mW
Resolution, typ.	1 mm
Repeat accuracy, typ.	1 mm
Update rate	100 Hz
Teach-in	✓
Reverse polarity protection	Yes
Short-circuit protection	Yes
Ambient operating temperature	-20 °C ... +70 °C
Shock and vibration resistance	30 g, 11 ms/10 Hz ... 55 Hz, 1 mm
EMC	EN 61000-6-2, EN 61000-6-4
Connection type	Cable, 4-wire, 3 m ¹⁾
Connection type Detail	
Conductor cross section	0.08 mm ²
Cable diameter	Ø 2.6 mm
Bending radius	With fixed installation > 5 x cable diameter For flexible use > 10 x cable diameter
Cable outlet	Axial
Material	

¹⁾ Do not bend below 0 °C.

Housing	Metal, Aluminum, plastic
Cable	PUR
UL File No.	NRKH.E181493 & NRKH7.E181493

¹⁾ Do not bend below 0 °C.

Safety-related parameters

MTTF_D	143 years
DC_{avg}	0 %
T_M (mission time)	20 years

Communication interface

Communication interface	Modbus
Communication Interface detail	RTU RS-485

Diagnosis

Orientation	
Number of axis	3
Roll Euler angle measuring range	± 180°
Pitch Euler angle measuring range	± 90°
Yaw Euler angle measuring range	± 180°
Resolution	0.02°
Roll repeatability	± 1°
Pitch repeatability	± 1°
Yaw repeatability	± 1° ¹⁾
Maximum rotation rate	2,000 °/s
Quaternion w measuring range	0 ... + 1
Quaternion x measuring range	-1 ... 1
Quaternion y measuring range	-1 ... 1
Quaternion z measuring range	-1 ... 1
Update rate	100 Hz
Limit frequency	100 Hz
Initialization time	640 ms
Sampling rate	200 Hz ²⁾
Acceleration measuring range	± 16 g ²⁾
Rotation rate measuring range	± 2,000 °/s ²⁾

¹⁾ Not long-term stable.

²⁾ Raw data.

Classifications

ECLASS 5.0	27270104
ECLASS 5.1.4	27270104
ECLASS 6.0	27270104
ECLASS 6.2	27270104
ECLASS 7.0	27270104
ECLASS 8.0	27270104

ECLASS 8.1	27270104
ECLASS 9.0	27270104
ECLASS 10.0	27270104
ECLASS 11.0	27270104
ECLASS 12.0	27274301
ETIM 5.0	EC002544
ETIM 6.0	EC002544
ETIM 7.0	EC002544
ETIM 8.0	EC002544
UNSPSC 16.0901	39122230

Connection diagram

Cd-557

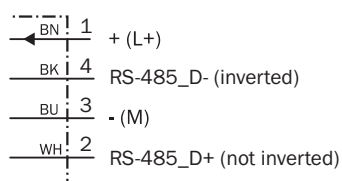

Dimensional drawing (Dimensions in mm (inch))

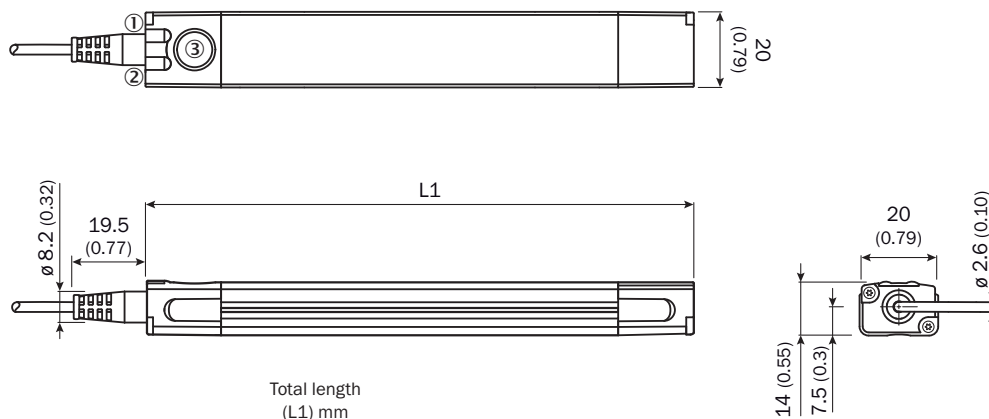







	Total length (L1) mm
MLSE-0200	217
MLSE-0300	325
MLSE-0400	397
MLSE-0500	505
MLSE-0600	613

- ① Function signal indicator 1
- ② Function signal indicator 2
- ③ Teach-Pad

Recommended accessories

Other models and accessories → www.sick.com/MLS

	Brief description	Type	Part no.
Magnets			
	Magnetic tape, North is top side, adhesive, width 25 mm, length 50 m	MAGNETIC TAPE	5337613
	Magnetic tape, South is top side, adhesive, width 25 mm, length 50 m	MAGNETIC TAPE	5337614
	Magnetic tape, north pole on top, self-adhesive, width = 25mm, external length = 524 mm, internal length = 511 mm, radius = 1000 mm, 30° section	Magnetic tape, curved	5344198
	Positioning device for magnetic markers (5337613, 5337614) for MLS	TEMPLATE	4097520
Mounting brackets and plates			
	Bracket for low mounting, Stainless steel V2A (bracket/mounting screw), Brass (fixing screw)	BEF-WNLO1MPA	2065973
	Bracket for lateral mounting, Stainless steel V2A (bracket/mounting screw), Brass (fixing screw)	BEF-WNZ01MPA	2065577
Others			
	<ul style="list-style-type: none"> • Connection type head A: Male connector, M8, 4-pin, straight, A-coded • Description: Unshielded • Connection systems: Screw-type terminals • Permitted cross-section: 0.14 mm² ... 0.5 mm² 	STE-0804-G	6037323
	<ul style="list-style-type: none"> • Connection type head A: Male connector, M12, 4-pin, straight, A-coded • Description: Unshielded • Connection systems: Screw-type terminals • Permitted cross-section: ≤ 0.75 mm² 	STE-1204-G	6009932

SICK AT A GLANCE

SICK is one of the leading manufacturers of intelligent sensors and sensor solutions for industrial applications. A unique range of products and services creates the perfect basis for controlling processes securely and efficiently, protecting individuals from accidents and preventing damage to the environment.

We have extensive experience in a wide range of industries and understand their processes and requirements. With intelligent sensors, we can deliver exactly what our customers need. In application centers in Europe, Asia and North America, system solutions are tested and optimized in accordance with customer specifications. All this makes us a reliable supplier and development partner.

Comprehensive services complete our offering: SICK LifeTime Services provide support throughout the machine life cycle and ensure safety and productivity.

For us, that is “Sensor Intelligence.”

WORLDWIDE PRESENCE:

Contacts and other locations –www.sick.com