



# WLA26P-P02

W26

COMPACT PHOTOELECTRIC SENSORS

**SICK**  
Sensor Intelligence.



Illustration may differ



### Ordering information

Type	Part no.
WLA26P-P02	1100803

Other models and accessories → [www.sick.com/W26](http://www.sick.com/W26)

### Detailed technical data

#### Features

<b>Functional principle</b>	Photoelectric retro-reflective sensor
<b>Functional principle detail</b>	Without reflector minimum distance (autocollimation/coaxial optics)
<b>Sensing range</b>	
Sensing range min.	0 m
Sensing range max.	18 m
Maximum distance range from reflector to sensor (operating reserve 1)	0 m ... 18 m
Recommended distance range from reflector to sensor (operating reserve 3,75)	0 m ... 12 m
Reference reflector	Reflector PL80A
Recommended sensing range for the best performance	0 m ... 12 m
<b>Polarisation filters</b>	Yes
<b>Emitted beam</b>	
Light source	PinPoint LED
Type of light	Visible red light
Shape of light spot	Point-shaped
Light spot size (distance)	Ø 100 mm (10 m)

Maximum dispersion of the emitted beam around the standardized transmission axis (squint angle)	< +/- 1.0° (at T <sub>a</sub> = +23 °C)
<b>Key LED figures</b>	
Normative reference	EN 62471:2008-09   IEC 62471:2006, modified
LED risk group marking	Free group
Wave length	635 nm
Average service life	100,000 h at T <sub>a</sub> = +25 °C
<b>Indication</b>	
LED blue	BluePilot: Alignment aid
LED yellow	Status of received light beam Static on: object not present Static off: object present Flashing: Below the 1.5 function reserve
<b>Special features</b>	With BEF-WN-W23, 2019085 and PL40A, 1012720
<b>Special applications</b>	Detecting objects wrapped in film
<b>Items supplied</b>	BEF-WN-W23 mounting bracket and PL40A reflector

### Safety-related parameters

<b>MTTF<sub>D</sub></b>	690 years
<b>DC<sub>avg</sub></b>	0%
<b>T<sub>M</sub> (mission time)</b>	20 years (EN ISO 13849, rate of use: 60 %)

### Communication interface

<b>IO-Link</b>	✓, V1.1
Data transmission rate	COM2 (38,4 kBaud)
Cycle time	2.3 ms
Process data length	16 Bit
Process data structure	Bit 0 = switching signal Q <sub>L1</sub> Bit 1 = switching signal Q <sub>L2</sub> Bit 2 ... 15 = empty
VendorID	26
DeviceID HEX	0x800180
DeviceID DEC	8388992
Compatible master port type	A
SIO mode support	Yes

### Electrical data

<b>Supply voltage U<sub>B</sub></b>	10 V DC ... 30 V DC <sup>1)</sup>
<b>Ripple</b>	≤ 5 V <sub>pp</sub>
<b>Usage category</b>	DC-12 (According to EN 60947-5-2) DC-13 (According to EN 60947-5-2)
<b>Current consumption</b>	≤ 30 mA, without load. At U <sub>B</sub> = 24 V
<b>Protection class</b>	III

<sup>1)</sup> Limit values.

<sup>2)</sup> Signal transit time with resistive load in switching mode.

<sup>3)</sup> With light/dark ratio 1:1.

<sup>4)</sup> This switching output must not be connected to another output.

<b>Digital output</b>	
Number	2 (Complementary)
Type	Push-pull: PNP/NPN
Switching mode	Light/dark switching
Signal voltage PNP HIGH/LOW	Approx. $U_B - 2.5 \text{ V} / 0 \text{ V}$
Signal voltage NPN HIGH/LOW	Approx. $U_B / < 2.5 \text{ V}$
Output current $I_{\text{max}}$	$\leq 100 \text{ mA}$
Circuit protection outputs	Reverse polarity protected Overcurrent and short-circuit protected
Response time	$\leq 500 \mu\text{s}$ <sup>2)</sup>
Repeatability (response time)	150 $\mu\text{s}$
Switching frequency	1,000 Hz <sup>3)</sup>
<b>Pin/Wire assignment</b>	
Function of pin 4/black (BK)	Digital output, light switching, object present → output $Q_{L1}$ LOW; IO-Link communication C <sup>4)</sup>
Function of pin 4/black (BK) – detail	The pin 4 function of the sensor can be configured, Additional possible settings via IO-Link
Function of pin 2/white (WH)	Digital output, dark switching, object present → output $\bar{Q}_{L1}$ HIGH <sup>4)</sup>
Function of pin 2/white (WH) – detail	The pin 2 function of the sensor can be configured, Additional possible settings via IO-Link

<sup>1)</sup> Limit values.

<sup>2)</sup> Signal transit time with resistive load in switching mode.

<sup>3)</sup> With light/dark ratio 1:1.

<sup>4)</sup> This switching output must not be connected to another output.

## Mechanical data

<b>Housing</b>	Rectangular
<b>Dimensions (W x H x D)</b>	24.6 mm x 82.5 mm x 53.3 mm
<b>Connection</b>	Cable, 4-wire, 2 m
<b>Connection detail</b>	
Deep-freeze property	Do not bend below 0 °C
Conductor size	0.14 mm <sup>2</sup>
Cable diameter	Ø 4.8 mm
Length of cable (L)	2 m
Bending radius	For flexible use > 12 x cable diameter
Bending cycles	1,000,000
<b>Material</b>	
Housing	Plastic, VISTAL®
Front screen	Plastic, PMMA
Cable	Plastic, PVC
<b>Weight</b>	Approx. 130 g
<b>Maximum tightening torque of the fixing screws</b>	1.3 Nm

## Ambient data

<b>Enclosure rating</b>	IP66 (EN 60529) IP67 (EN 60529)
-------------------------	------------------------------------

<sup>1)</sup> Replaces IP69K with ISO 20653: 2013-03.

	IP69 (EN 60529) <sup>1)</sup>
<b>Ambient operating temperature</b>	-40 °C ... +60 °C
<b>Ambient temperature, storage</b>	-40 °C ... +75 °C
<b>Shock resistance</b>	50 g, 11 ms (25 positive and 25 negative shocks per axis, for X, Y, Z axes, 150 shocks in total (EN60068-2-27)) 50 g, 6 ms (5,000 positive and 5,000 negative shocks per axis, for X, Y, Z axes, 30,000 shocks in total (EN60068-2-27))
<b>Vibration resistance</b>	10 Hz ... 2,000 Hz (Amplitude 0.5 mm / 10 g, 20 sweeps per axis, for X, Y, Z axes, 1 octave/min, (EN60068-2-6))
<b>Air humidity</b>	35 % ... 95 %, relative humidity (no condensation)
<b>Electromagnetic compatibility (EMC)</b>	EN 60947-5-2
<b>Resistance to cleaning agent</b>	ECOLAB
<b>UL File No.</b>	NRKH.E181493 & NRKH7.E181493

<sup>1)</sup> Replaces IP69K with ISO 20653: 2013-03.

## Smart Task

<b>Smart Task name</b>	Base logics
<b>Logic function</b>	Direct AND OR Window Hysteresis
<b>Timer function</b>	Deactivated Switch-on delay Off delay ON and OFF delay Impulse (one shot)
<b>Inverter</b>	Yes
<b>Switching frequency</b>	SIO Logic: 800 Hz <sup>1)</sup> IOL: 650 Hz <sup>2)</sup>
<b>Response time</b>	SIO Logic: 600 µs <sup>1)</sup> IOL: 750 µs <sup>2)</sup>
<b>Repeatability</b>	SIO Logic: 300 µs <sup>1)</sup> IOL: 400 µs <sup>2)</sup>
<b>Switching signal</b>	
Switching signal $Q_{L1}$	Switching output
Switching signal $\bar{Q}_{L1}$	Switching output

<sup>1)</sup> Use of Smart Task functions without IO-Link communication (SIO mode).

<sup>2)</sup> Use of Smart Task functions with IO-Link communication function.

## Diagnosis

<b>Device status</b>	Yes
----------------------	-----

## Classifications

<b>ECLASS 5.0</b>	27270902
<b>ECLASS 5.1.4</b>	27270902
<b>ECLASS 6.0</b>	27270902
<b>ECLASS 6.2</b>	27270902
<b>ECLASS 7.0</b>	27270902

<b>ECLASS 8.0</b>	27270902
<b>ECLASS 8.1</b>	27270902
<b>ECLASS 9.0</b>	27270902
<b>ECLASS 10.0</b>	27270902
<b>ECLASS 11.0</b>	27270902
<b>ECLASS 12.0</b>	27270902
<b>ETIM 5.0</b>	EC002717
<b>ETIM 6.0</b>	EC002717
<b>ETIM 7.0</b>	EC002717
<b>ETIM 8.0</b>	EC002717
<b>UNSPSC 16.0901</b>	39121528

### Dimensional drawing (Dimensions in mm (inch))

Dimensional drawing, sensor

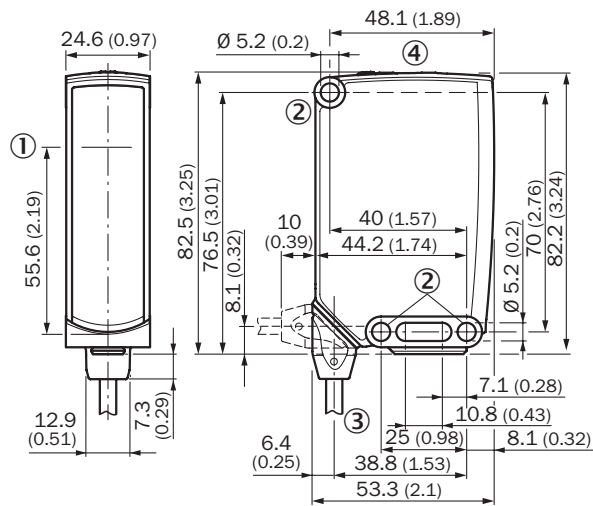

- ① Center of optical axis
- ② Mounting hole,  $\varnothing 5.2$  mm
- ③ Connection
- ④ Display and adjustment elements

### Connection diagram

Cd-389

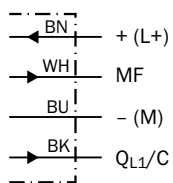

Truth table

Push-pull: PNP/NPN - light switching Q

	Light switching Q (normally closed (upper switch), normally open (lower switch))	
	Object not present → Output HIGH	Object present → Output LOW
Light receive	✓	✗
Light receive indicator	☉	✗
Load resistance to L+	✗	⚠
Load resistance to M	⚠	✗

Push-pull: PNP/NPN – dark switching  $\bar{Q}$

	Dark switching $\bar{Q}$ (normally open (upper switch), normally closed (lower switch))	
	Object not present → Output LOW	Object present → Output HIGH
Light receive	✓	✗
Light receive indicator	☉	✗
Load resistance to L+	⚠	✗
Load resistance to M	✗	⚠

### Characteristic curve

Reflective tape

Operating reserve

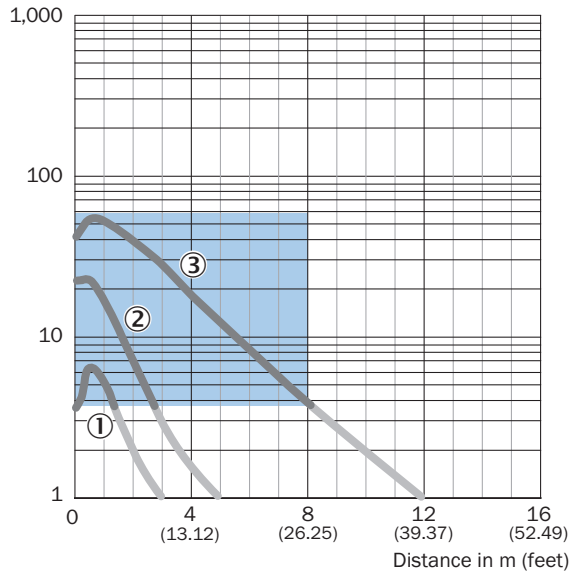

Recommended sensing range for the best performance

- ① Reflective tape REF-DG (50 x 50 mm)
- ② Reflective tape REF-IRF-56 (50 x 50 mm)
- ③ Reflective tape REF-AC1000 (50 x 50 mm)

Standard reflectors

Operating reserve

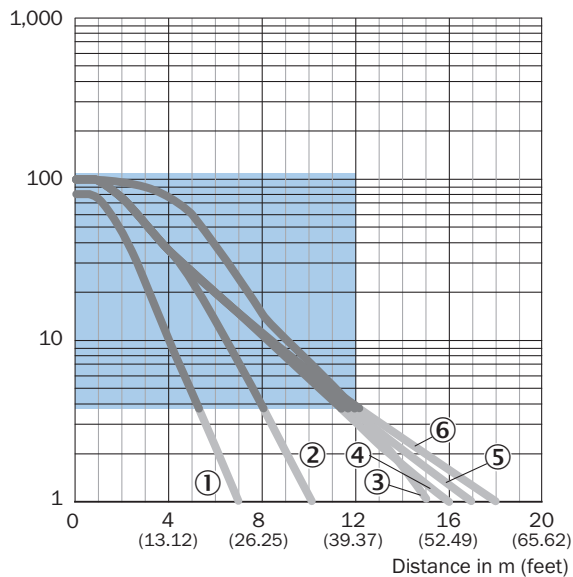

Recommended sensing range for the best performance

- ① Reflector PL20A
- ② Reflector PL22
- ③ Reflector PL250
- ④ Reflector PL30A
- ⑤ Reflector PL40A
- ⑥ Reflector PL80A, C110A



Chemical-resistant reflectors

Operating reserve

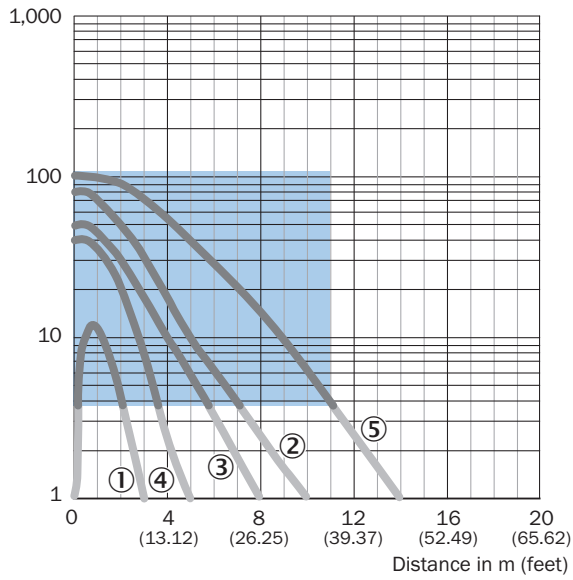

Recommended sensing range for the best performance

- ① PL10F CHEM reflector
- ② Reflector P250H
- ③ Reflector P250 CHEM
- ④ Reflector PL20 CHEM
- ⑤ Reflector PL40A Antifog

Fine triple reflectors

Operating reserve

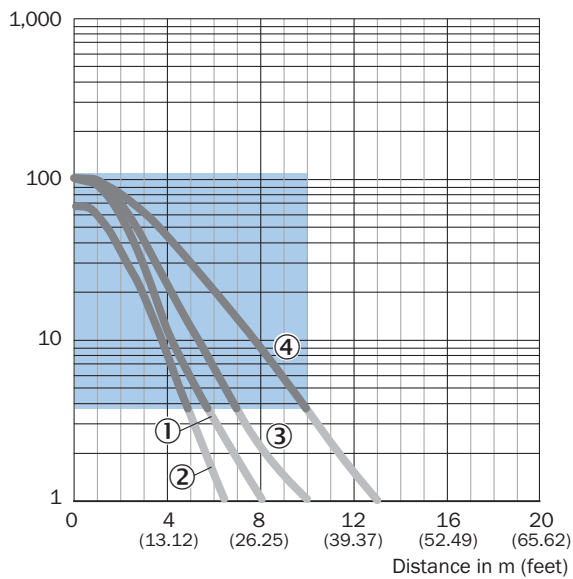

Recommended sensing range for the best performance

- ① PL10FH-1 reflector
- ② PL10F reflector
- ③ Reflector PL20F
- ④ Reflector P250F

### Light spot size

WLA26P-xxxxx1xx

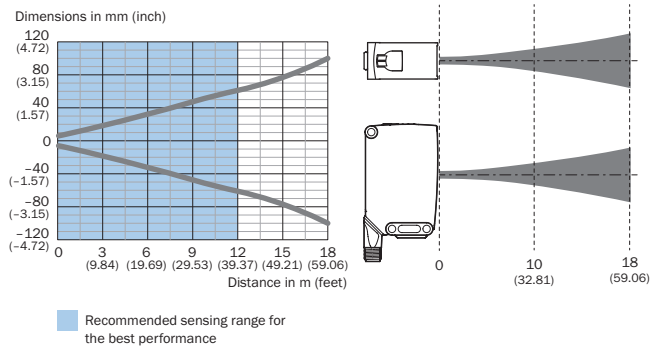

### Sensing range diagram

Standard reflectors

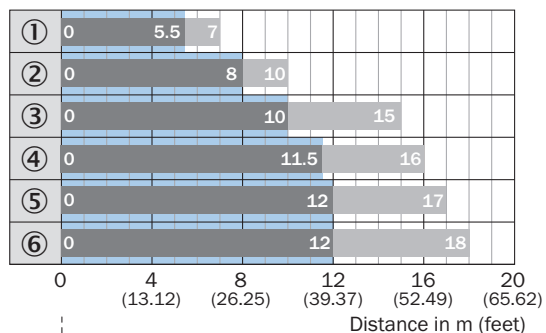

Recommended sensing range for the best performance

1	Reflector PL20A
2	Reflector PL22
3	Reflector P250
4	Reflector PL30A
5	Reflector PL40A
6	Reflector PL80A, C110A
A	Sensing range min. in m
B	Sensing range max. in m
C	Maximum distance range from reflector to sensor (operating reserve 1)
D	Recommended distance range from reflector to sensor (operating reserve 3,75)

Reflective tape

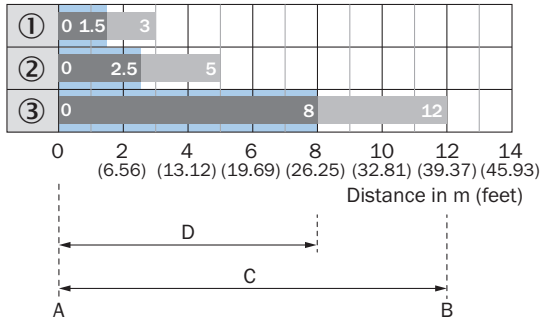

Recommended sensing range for the best performance

1	Reflective tape REF-DG (50 x 50 mm)
2	Reflective tape REF-IRF-56 (50 x 50 mm)
3	Reflective tape REF-AC1000 (50 x 50 mm)
A	Sensing range min. in m
B	Sensing range max. in m
C	Maximum distance range from reflector to sensor (operating reserve 1)
D	Recommended distance range from reflector to sensor (operating reserve 3,75)

Fine triple reflectors

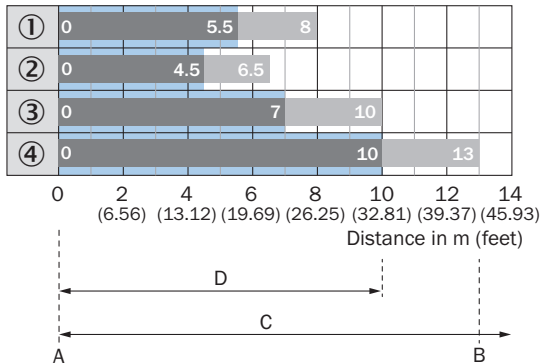

Recommended sensing range for the best performance

1	PL10FH-1 reflector
2	PL10F reflector
3	Reflector PL20F
4	Reflector P250F
A	Sensing range min. in m
B	Sensing range max. in m
C	Maximum distance range from reflector to sensor (operating reserve 1)
D	Recommended distance range from reflector to sensor (operating reserve 3,75)

### Chemical-resistant reflectors

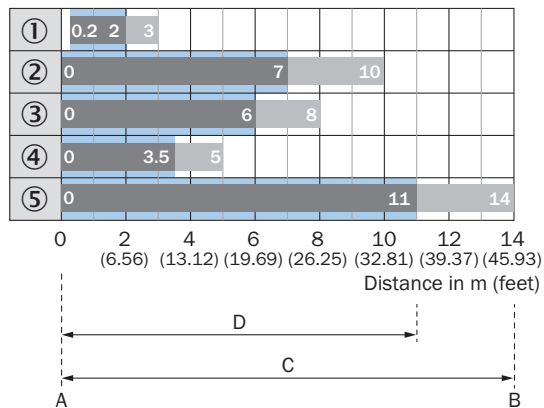

Recommended sensing range for the best performance

1	PL10F CHEM reflector
2	Reflector P250H
3	Reflector P250 CHEM
4	Reflector PL20 CHEM
5	Reflector PL40A Antifog
A	Sensing range min. in m
B	Sensing range max. in m
C	Maximum distance range from reflector to sensor (operating reserve 1)
D	Recommended distance range from reflector to sensor (operating reserve 3,75)

## Functions

### Operation note

BluePilot: Blue indicator LEDs with double benefits

<p>Easy and quick sensor alignment with the help of the LED indicator</p> <p>All blue LEDs illuminate</p> <ul style="list-style-type: none"> <li>- optimum alignment</li> <li>- highest possible operating reserve</li> </ul>	<p>WLA photoelectric retro-reflection sensor alignment</p>
<p><b>Service note</b></p> <p>A reduction in sensor availability is displayed by a decrease of the blue LEDs.</p> <p>Possible causes:</p> <ul style="list-style-type: none"> <li>a) insufficient alignment</li> <li>b) contamination of the optical surfaces</li> <li>c) particles in the light beam</li> </ul>	

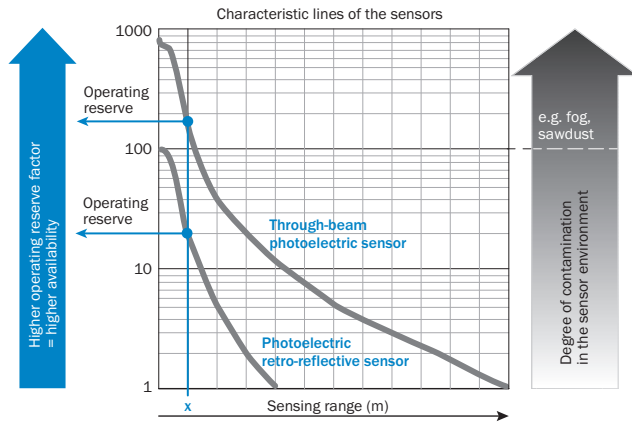

Operation note



At a sensing range of „x“ the photoelectric retro-reflective and through-beam photoelectric sensors have different operating reserves (see blue arrow). The higher the operating reserve factor, the better the sensor can compensate the contamination in the air or in the light beam and on the optical surfaces (front screen, reflector), i.e. the sensor has the maximum availability, otherwise the sensor switches due to pollution although there is no object in the path of the light beam.

Recommended accessories

Other models and accessories → [www.sick.com/W26](http://www.sick.com/W26)

	Brief description	Type	Part no.
<b>Universal bar clamp systems</b>			
	Plate N12 for universal clamp. For mounting PL30A, P250 reflectors, W27 and WTR2 sensors., Zinc plated steel (sheet), Zinc die cast (clamping bracket), Universal clamp (2022726), mounting hardware	BEF-KHS-N12	2071950
<b>Mounting brackets and plates</b>			
	Universal mounting bracket for reflectors, steel, zinc coated	BEF-WN-REFX	2064574
<b>Reflectors</b>			
	Rectangular, screw connection, 84 mm x 84 mm, PMMA/ABS, Screw-on, 2 hole mounting	PL80A	1003865

### Recommended services

Additional services → [www.sick.com/W26](http://www.sick.com/W26)

	Type	Part no.
Function Block Factory		
<ul style="list-style-type: none"><li>• <b>Description:</b> The Function Block Factory supports common programmable logic controllers (PLCs) from various manufacturers, such as Siemens, Beckhoff, Rockwell Automation and B&amp;R. More information on the FBF can be found <a _blank"="" href="https://fbf.cloud.sick.com target=">here</a>.</li><li>• <b>Note:</b> You can configure your function block at <a _blank"="" href="https://fbf.cloud.sick.com target=">Function Block Factory</a>. As a login please use your SICK ID.</li></ul>	Function Block Factory	On request

## SICK AT A GLANCE

SICK is one of the leading manufacturers of intelligent sensors and sensor solutions for industrial applications. A unique range of products and services creates the perfect basis for controlling processes securely and efficiently, protecting individuals from accidents and preventing damage to the environment.

We have extensive experience in a wide range of industries and understand their processes and requirements. With intelligent sensors, we can deliver exactly what our customers need. In application centers in Europe, Asia and North America, system solutions are tested and optimized in accordance with customer specifications. All this makes us a reliable supplier and development partner.

Comprehensive services complete our offering: SICK LifeTime Services provide support throughout the machine life cycle and ensure safety and productivity.

For us, that is “Sensor Intelligence.”

## WORLDWIDE PRESENCE:

Contacts and other locations –[www.sick.com](http://www.sick.com)