

# AFM60A-BGEB000S34

AFS/AFM60 Ethernet

**ABSOLUTE ENCODERS**

**SICK**  
Sensor Intelligence.

Illustration may differ

### Ordering information

| Type              | Part no. |
|-------------------|----------|
| AFM60A-BGEB000S34 | 1103092  |

Other models and accessories → [www.sick.com/AFS\\_AFM60\\_Ethernet](http://www.sick.com/AFS_AFM60_Ethernet)



### Detailed technical data

#### Features

|                                  |                            |
|----------------------------------|----------------------------|
| <b>Special device</b>            | ✓                          |
| <b>Specialty</b>                 | Customized stator coupling |
| <b>Standard reference device</b> | AFM60A-BGEB018X12, 1059054 |

#### Performance

|   |                                   |
|---|-----------------------------------|
| <b>Number of steps per revolution (max. resolution)</b>                         | 262,144 (18 bit)                  |
| <b>Number of revolutions</b>  | 4,096 (12 bit)                    |
| <b>Max. resolution (number of steps per revolution x number of revolutions)</b> | 18 bit x 12 bit (262,144 x 4,096) |
| <b>Error limits G</b>   | 0.03° <sup>1)</sup>               |
| <b>Repeatability standard deviation <math>\sigma_r</math></b>                   | 0.002° <sup>2)</sup>              |

<sup>1)</sup> In accordance with DIN ISO 1319-1, position of the upper and lower error limit depends on the installation situation, specified value refers to a symmetrical position, i.e. deviation in upper and lower direction is the same.

<sup>2)</sup> In accordance with DIN ISO 55350-13; 68.3% of the measured values are inside the specified area.

#### Interfaces

|   |  |
|---|--|
| <b>Communication interface</b>            | EtherCAT®  |
| <b>Communication Interface detail</b>     | CoE (CAN over EtherCAT®)   |
| <b>Encoder profile</b>                    | CiA DS-406   |
| <b>Data transmission rate (baud rate)</b> | 10 Mbit/s, 100 Mbit/s  |
| <b>Transmission medium</b>                | CAT-5e cable   |
| <b>Initialization time</b>                | 6 s  |
| <b>Cycle time</b>                         | 125 µs ... 100 ms  |
| <b>Parameterising data</b>                | Number of steps per revolution<br>Number of revolutions<br>PRESET<br>Counting direction<br>Sampling rate for speed calculation<br>Unit for output of the speed value<br>Round axis functionality<br>Singleturn or multiturn access mode<br>Quicker data exchange mode<br>Electronic cams |
| <b>Available diagnostics data</b>         | Minimum and maximum temperature<br>Maximum speed<br>Position monitoring  |

|  |   |
|--|---|
|  | Power-on counter<br>Operating hours counter power-on/motion<br>Counter of direction changes/number of movements cw/number of movements ccw<br>Minimum and maximum operating voltage<br>Signal monitoring for single turn and multi turn |
|--|---|

## Electrical data

|   |   |
|---|---|
| <b>Connection type</b>                      | Male connector, Female connector, 1x, 2x, M12, M12, 4-pin, 4-pin, axial, axial <sup>1) 2)</sup> |
| <b>Supply voltage</b>                       | 10 ... 30 V   |
| <b>Power consumption</b>                    | ≤ 3 W (without load)  |
| <b>Reverse polarity protection</b>          | ✓   |
| <b>MTTF: mean time to dangerous failure</b> | 80 years (EN ISO 13849-1) <sup>3)</sup>   |

<sup>1)</sup> A-coded.

<sup>2)</sup> D-coded.

<sup>3)</sup> This product is a standard product and does not constitute a safety component as defined in the Machinery Directive. Calculation based on nominal load of components, average ambient temperature 40 °C, frequency of use 8760 h/a. All electronic failures are considered hazardous. For more information, see document no. 8015532.

## Mechanical data

|                                       |   |
|---------------------------------------|---|
| <b>Mechanical design</b>              | Blind hollow shaft                      |
| <b>Shaft diameter</b>                 | 14 mm                                   |
| <b>Weight</b>                         | 0.2 kg                                  |
| <b>Shaft material</b>                 | Stainless steel                         |
| <b>Flange material</b>                | Aluminum                                |
| <b>Housing material</b>               | Aluminum                                |
| <b>Start up torque</b>                | 0.8 Ncm (+20 °C)                        |
| <b>Operating torque</b>               | 0.6 Ncm (+20 °C)                        |
| <b>Permissible movement static</b>    | ± 0.3 mm (radial)<br>± 0.5 mm (axial)   |
| <b>Permissible movement dynamic</b>   | ± 0.05 mm (radial)<br>± 0.1 mm (axial)  |
| <b>Operating speed</b>                | ≤ 6,000 min <sup>-1</sup> <sup>1)</sup> |
| <b>Moment of inertia of the rotor</b> | 40 gcm <sup>2</sup>                     |
| <b>Bearing lifetime</b>               | 3 x 10 <sup>9</sup> revolutions         |
| <b>Angular acceleration</b>           | ≤ 500,000 rad/s <sup>2</sup>            |

<sup>1)</sup> Allow for self-heating of 3.3 K per 1,000 rpm when designing the operating temperature range.

## Ambient data

|                                      |  |
|--------------------------------------|--|
| <b>EMC</b>                           | According to EN 61000-6-2 and EN 61000-6-3 <sup>1)</sup>                     |
| <b>Enclosure rating</b>              | IP65, shaft side (IEC 60529)<br>IP67, housing side (IEC 60529) <sup>2)</sup> |
| <b>Permissible relative humidity</b> | 90 % (Condensation not permitted)  |
| <b>Operating temperature range</b>   | -40 °C ... +85 °C  |
| <b>Storage temperature range</b>     | -40 °C ... +100 °C, without package  |
| <b>Resistance to shocks</b>          | 100 g, 6 ms (EN 60068-2-27)  |

<sup>1)</sup> The EMC according to the standards quoted is achieved if screened cables are used.

<sup>2)</sup> With mating connector fitted.

|                                |   |
|--------------------------------|---|
| <b>Resistance to vibration</b> | 30 g, 10 Hz ... 2,000 Hz (EN 60068-2-6) |
|--------------------------------|---|

<sup>1)</sup> The EMC according to the standards quoted is achieved if screened cables are used.

<sup>2)</sup> With mating connector fitted.

### Classifications

|                       |          |
|-----------------------|----------|
| <b>eCl@ss 5.0</b>     | 27270502 |
| <b>eCl@ss 5.1.4</b>   | 27270502 |
| <b>eCl@ss 6.0</b>     | 27270590 |
| <b>eCl@ss 6.2</b>     | 27270590 |
| <b>eCl@ss 7.0</b>     | 27270502 |
| <b>eCl@ss 8.0</b>     | 27270502 |
| <b>eCl@ss 8.1</b>     | 27270502 |
| <b>eCl@ss 9.0</b>     | 27270502 |
| <b>eCl@ss 10.0</b>    | 27270502 |
| <b>eCl@ss 11.0</b>    | 27270502 |
| <b>eCl@ss 12.0</b>    | 27270502 |
| <b>ETIM 5.0</b>       | EC001486 |
| <b>ETIM 6.0</b>       | EC001486 |
| <b>ETIM 7.0</b>       | EC001486 |
| <b>ETIM 8.0</b>       | EC001486 |
| <b>UNSPSC 16.0901</b> | 41112113 |

Dimensional drawing (Dimensions in mm (inch))

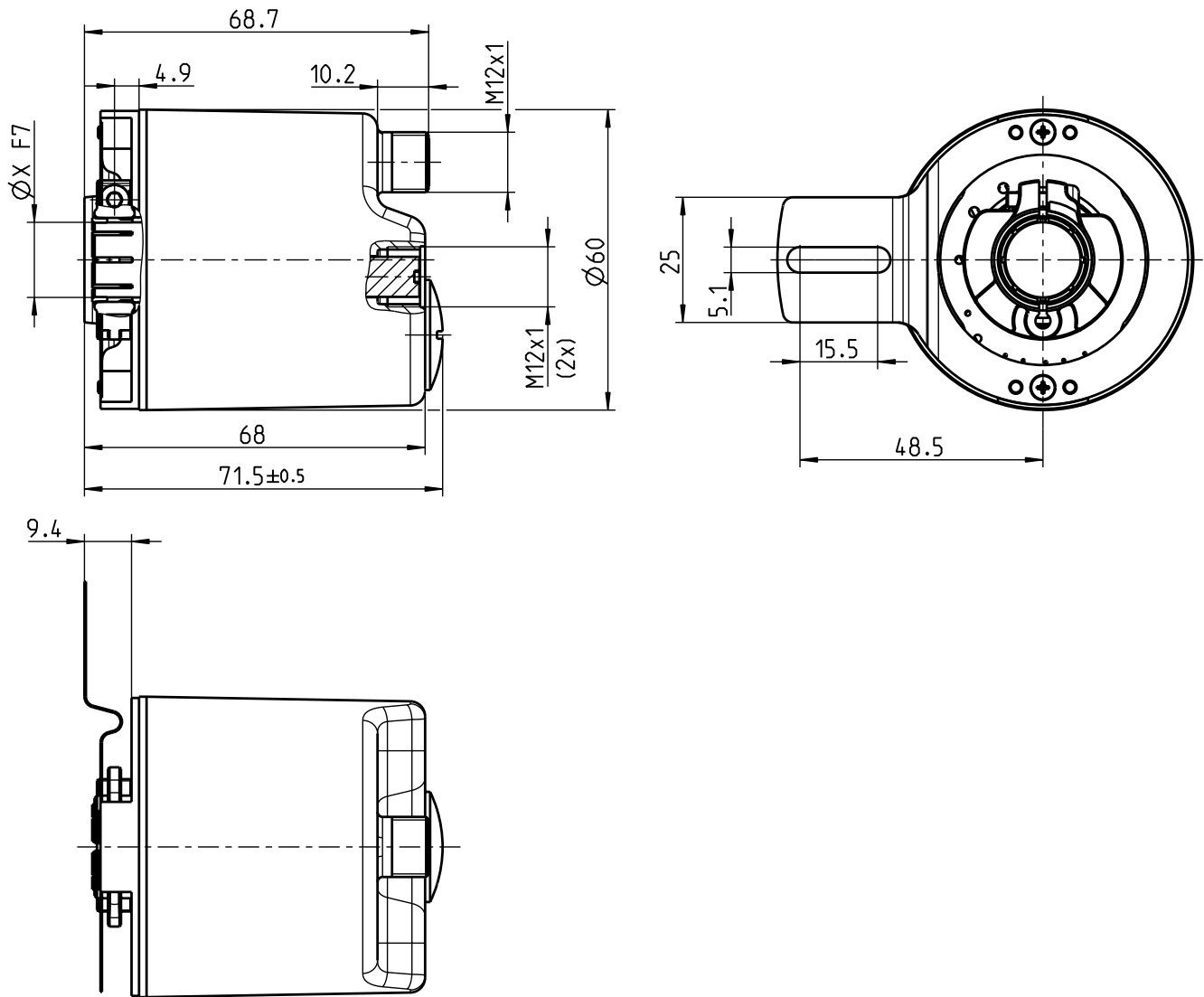

PIN assignment

Male connector

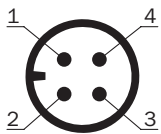

Supply voltage

| PIN | Wire color | Signal                       |
|-----|------------|------------------------------|
| 1   | Brown      | U <sub>S</sub> 10 V ... 30 V |
| 2   | White      | Not assigned                 |
| 3   | Blue       | GND                          |
| 4   | Black      | Not assigned                 |

Female connector

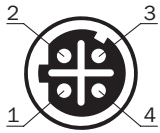

Port 1, Port 2

| PIN | Wire color | Signal |
|-----|------------|--------|
| 1   | Yellow     | T x D+ |
| 2   | White      | R x D+ |
| 3   | Orange     | T x D- |
| 4   | Blue       | R x D- |



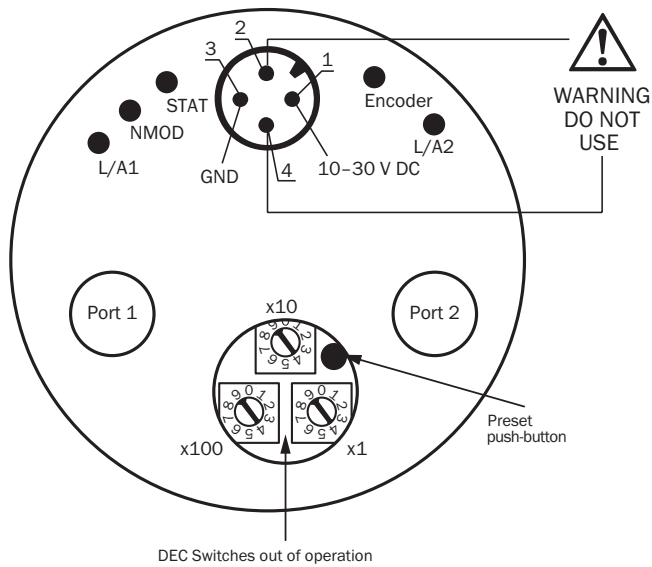





### Connection diagram



### Recommended accessories

Other models and accessories → [www.sick.com/AFS\\_AFM60\\_Ethernet](http://www.sick.com/AFS_AFM60_Ethernet)

|                | Brief description   | Type              | Part no. |
|----------------|---|-------------------|----------|
| <b>Flanges</b> |   |                   |          |
|                | Flange adapter, adaptation of face mount flange with 36 mm centering hub to 50 mm servo flange, aluminum, including 3 flat head screws M4 x 10, Aluminum, including 3 countersunk screws M3 x 10        | BEF-FA-036-050    | 2029160  |
|                | Flange adapter, adaptation of face mount flange with 36 mm centering hub to 60 mm square mounting plate, aluminum, including 3 flat head screws M4 x 8, Aluminum, including 3 countersunk screws M4 x 8 | BEF-FA-036-060REC | 2029162  |

|   | Brief description   | Type               | Part no. |
|---|---|--------------------|----------|
|    | Flange adapter, adaptation of face mount flange with 36 mm centering hub to 58 mm square mounting plate with shock absorbers, aluminum, Aluminum  | BEF-FA-036-060RSA  | 2029163  |
|    | Flange adapter, adaptation of face mount flange with 36 mm centering hub to 63 mm square mounting plate, aluminum, including 3 flat head screws M4 x 10, Aluminum, including 3 countersunk screws M3 x 10 | BEF-FA-036-063REC  | 2034225  |
| <b>Other mounting accessories</b>   |   |                    |          |
|    | Plastic measuring wheel with smooth plastic surface (Hytrel), for 10 mm solid shaft, circumference 200 mm   | BEF-MR-010020      | 5312988  |
|    | Measuring wheel with ridged plastic surface (Hytrel) for 10 mm solid shaft, circumference 200 mm  | BEF-MR-010020G     | 5318678  |
|    | Plastic measuring wheel with smooth plastic surface (Hytrel) for 10 mm solid shaft, circumference 500 mm  | BEF-MR-010050      | 5312989  |
|    | Aluminium measuring wheel with O-ring (NBR70) for 6 mm solid shaft, circumference 200 mm  | BEF-MR006020R      | 2055222  |
|   | Measuring wheel with O-ring (NBR70) for 6 mm solid shaft, circumference 300 mm  | BEF-MR006030R      | 2055634  |
|   | Aluminium measuring wheel with O-ring (NBR70) for 10 mm solid shaft, circumference 200 mm   | BEF-MR010020R      | 2055224  |
|   | Aluminium measuring wheel with O-ring (NBR70) for 10 mm solid shaft, circumference 300 mm   | BEF-MR010030R      | 2049278  |
|   | Measuring wheel with O-ring (NBR70) for 10 mm solid shaft, circumference 500 mm   | BEF-MR010050R      | 2055227  |
|   | O-ring for measuring wheels (circumference 200 mm)  | BEF-OR-053-040     | 2064061  |
|   | O-ring for measuring wheels (circumference 300 mm), 2x O-ring   | BEF-OR-083-050     | 2064076  |
|   | <b>Plug connectors and cables</b>   |                    |          |
|  | Head A: female connector, M12, 4-pin, straight, A-coded<br>Head B: Flying leads<br>Cable: Sensor/actuator cable, PUR, halogen-free, unshielded, 2 m   | YF2A14-020UB3XLEAX | 2095607  |
|   | Head A: female connector, M12, 4-pin, straight, A-coded<br>Head B: Flying leads<br>Cable: Sensor/actuator cable, PUR, halogen-free, unshielded, 5 m   | YF2A14-050UB3XLEAX | 2095608  |
|   | Head A: female connector, M12, 4-pin, straight, A-coded<br>Head B: Flying leads<br>Cable: Sensor/actuator cable, PUR, halogen-free, unshielded, 10 m  | YF2A14-100UB3XLEAX | 2095609  |
|   | Head A: female connector, M12, 4-pin, straight, A-coded<br>Head B: Flying leads<br>Cable: Sensor/actuator cable, PUR, halogen-free, unshielded, 25 m  | YF2A14-250UB3XLEAX | 2095615  |
|  | Head A: female connector, M12, 4-pin, angled, A-coded<br>Head B: Flying leads<br>Cable: Sensor/actuator cable, PUR, halogen-free, unshielded, 2 m   | YG2A14-020UB3XLEAX | 2095766  |
|   | Head A: female connector, M12, 4-pin, angled, A-coded<br>Head B: Flying leads<br>Cable: Sensor/actuator cable, PUR, halogen-free, unshielded, 5 m   | YG2A14-050UB3XLEAX | 2095767  |
|   | Head A: female connector, M12, 4-pin, angled, A-coded<br>Head B: Flying leads<br>Cable: Sensor/actuator cable, PUR, halogen-free, unshielded, 10 m  | YG2A14-100UB3XLEAX | 2095768  |
|   | Head A: female connector, M12, 4-pin, angled, A-coded<br>Head B: Flying leads<br>Cable: Sensor/actuator cable, PUR, halogen-free, unshielded, 25 m  | YG2A14-250UB3XLEAX | 2095771  |

|   | Brief description  | Type               | Part no. |
|---|--|--------------------|----------|
|    | Head A: male connector, M12, 4-pin, straight, D-coded<br>Head B: Flying leads<br>Cable: Ethernet, PROFINET, PUR, halogen-free, shielded, 2 m                                   | YM2D24-020PN1XLEAX | 2106171  |
|   | Head A: male connector, M12, 4-pin, straight, D-coded<br>Head B: Flying leads<br>Cable: Ethernet, PROFINET, PUR, halogen-free, shielded, 5 m                                   | YM2D24-050PN1XLEAX | 2106172  |
|   | Head A: male connector, M12, 4-pin, straight, D-coded<br>Head B: Flying leads<br>Cable: Ethernet, PROFINET, PUR, halogen-free, shielded, 10 m                                  | YM2D24-100PN1XLEAX | 2106173  |
|    | Head A: male connector, M12, 4-pin, angled, D-coded<br>Head B: Flying leads<br>Cable: Ethernet, PROFINET, PUR, halogen-free, shielded, 2 m                                     | YN2D24-020PN1XLEAX | 2106174  |
|   | Head A: male connector, M12, 4-pin, angled, D-coded<br>Head B: Flying leads<br>Cable: Ethernet, PROFINET, PUR, halogen-free, shielded, 5 m                                     | YN2D24-050PN1XLEAX | 2106175  |
|   | Head A: male connector, M12, 4-pin, angled, D-coded<br>Head B: Flying leads<br>Cable: Ethernet, PROFINET, PUR, halogen-free, shielded, 10 m                                    | YN2D24-100PN1XLEAX | 2106176  |
|   | Head A: male connector, M12, 4-pin, angled, D-coded<br>Head B: Flying leads<br>Cable: Ethernet, PROFINET, PUR, halogen-free, shielded, 25 m                                    | YN2D24-250PN1XLEAX | 2106180  |
|    | Head A: male connector, M12, 4-pin, angled, D-coded<br>Head B: male connector, M12, 4-pin, angled, D-coded<br>Cable: PROFINET, PUR, halogen-free, shielded, 5 m                | SSL-1204-W05MZ     | 6050636  |
|    | Head A: male connector, RJ45, 4-pin, straight<br>Head B: male connector, M12, 4-pin, angled, D-coded<br>Cable: PROFINET, EtherCAT®, PVC, shielded, 30 m                        | SSL-2J04-F30MZ     | 6059450  |
|  | Head A: male connector, M12, 4-pin, straight, D-coded<br>Head B: male connector, RJ45, 4-pin, straight<br>Cable: PROFINET, PVC, shielded, 5 m                                  | SSL-2J04-G05MZ60   | 6048245  |
|  | Head A: male connector, M12, 4-pin, straight, D-coded<br>Head B: male connector, M12, 4-pin, straight, D-coded<br>Cable: Ethernet, PROFINET, PUR, halogen-free, shielded, 2 m  | YM2D24-020PN1M2D24 | 2106159  |
|  | Head A: male connector, M12, 4-pin, straight, D-coded<br>Head B: male connector, RJ45, 4-pin, straight<br>Cable: Ethernet, PROFINET, PUR, halogen-free, shielded, 2 m          | YM2D24-020PN1MRJA4 | 2106182  |
|  | Head A: male connector, M12, 4-pin, straight, D-coded<br>Head B: male connector, M12, 4-pin, angled, D-coded<br>Cable: Ethernet, PROFINET, PUR, halogen-free, shielded, 2 m    | YM2D24-020PN1N2D24 | 2106165  |
|  | Head A: male connector, M12, 4-pin, straight, D-coded<br>Head B: male connector, M12, 4-pin, straight, D-coded<br>Cable: Ethernet, PROFINET, PUR, halogen-free, shielded, 5 m  | YM2D24-050PN1M2D24 | 2106160  |
|  | Head A: male connector, M12, 4-pin, straight, D-coded<br>Head B: male connector, M12, 4-pin, angled, D-coded<br>Cable: Ethernet, PROFINET, PUR, halogen-free, shielded, 5 m    | YM2D24-050PN1N2D24 | 2106166  |
|  | Head A: male connector, M12, 4-pin, straight, D-coded<br>Head B: male connector, M12, 4-pin, straight, D-coded<br>Cable: Ethernet, PROFINET, PUR, halogen-free, shielded, 10 m | YM2D24-100PN1M2D24 | 2106161  |
|  | Head A: male connector, M12, 4-pin, straight, D-coded<br>Head B: male connector, RJ45, 4-pin, straight<br>Cable: Ethernet, PROFINET, PUR, halogen-free, shielded, 10 m         | YM2D24-100PN1MRJA4 | 2106185  |
|  | Head A: male connector, M12, 4-pin, straight, D-coded<br>Head B: male connector, M12, 4-pin, angled, D-coded<br>Cable: Ethernet, PROFINET, PUR, halogen-free, shielded, 10 m   | YM2D24-100PN1N2D24 | 2106167  |



|   | Brief description  | Type  | Part no. |
|---|--|---|----------|
|    | Head A: male connector, M12, 4-pin, angled, D-coded<br>Head B: male connector, RJ45, 4-pin, straight<br>Cable: Ethernet, PROFINET, PUR, halogen-free, shielded, 2 m        | YN2D24-020PN1MRJA4                            | 2106162  |
|    | Head A: male connector, M12, 4-pin, angled, D-coded<br>Head B: male connector, M12, 4-pin, angled, D-coded<br>Cable: Ethernet, PROFINET, PUR, halogen-free, shielded, 2 m  | YN2D24-020PN1N2D24                            | 2106168  |
|    | Head A: male connector, M12, 4-pin, angled, D-coded<br>Head B: male connector, RJ45, 4-pin, straight<br>Cable: Ethernet, PROFINET, PUR, halogen-free, shielded, 5 m        | YN2D24-050PN1MRJA4                            | 2106163  |
|   | Head A: male connector, M12, 4-pin, angled, D-coded<br>Head B: male connector, RJ45, 4-pin, straight<br>Cable: Ethernet, PROFINET, PUR, halogen-free, shielded, 10 m       | YN2D24-100PN1MRJA4                            | 2106164  |
|    | Head A: male connector, M12, 4-pin, angled, D-coded<br>Head B: male connector, M12, 4-pin, angled, D-coded<br>Cable: Ethernet, PROFINET, PUR, halogen-free, shielded, 10 m | YN2D24-100PN1N2D24                            | 2106170  |
|    | Head A: female connector, M12, 4-pin, straight, D-coded<br>Cable: PROFINET, shielded   | DOS-1204-GZ                                   | 6048263  |
|    | Head A: female connector, M12, 4-pin, angled<br>Cable: unshielded  | DOS-1204-W                                    | 6007303  |
|    | Head A: female connector, M12, 4-pin, angled, D-coded<br>Cable: PROFINET, shielded   | DOS-1204-WZ                                   | 6048264  |
|   | Head A: male connector, RJ45, 4-pin, straight<br>Cable: Ethernet, PROFINET, EtherCAT®, shielded  | STE-0J04-GZ                                   | 6048260  |
|  | Head A: male connector, M12, 4-pin, straight, D-coded<br>Cable: PROFINET, shielded   | STE-1204-GZ                                   | 6048261  |
|  | Head A: male connector, M12, 4-pin, angled, D-coded<br>Cable: PROFINET, shielded   | STE-1204-WZ                                   | 6048262  |
|  | Head A: female connector, M12, 4-pin, D-coded<br>Head B: female connector, RJ45, 8-pin<br>Cable: Ethernet, shielded<br>Cabinet through                                     | Feedthrough female connector<br>Ethernet RJ45 | 6048180  |

## SICK AT A GLANCE

SICK is one of the leading manufacturers of intelligent sensors and sensor solutions for industrial applications. A unique range of products and services creates the perfect basis for controlling processes securely and efficiently, protecting individuals from accidents and preventing damage to the environment.

We have extensive experience in a wide range of industries and understand their processes and requirements. With intelligent sensors, we can deliver exactly what our customers need. In application centers in Europe, Asia and North America, system solutions are tested and optimized in accordance with customer specifications. All this makes us a reliable supplier and development partner.

Comprehensive services complete our offering: SICK LifeTime Services provide support throughout the machine life cycle and ensure safety and productivity.

For us, that is “Sensor Intelligence.”

## WORLDWIDE PRESENCE:

Contacts and other locations –[www.sick.com](http://www.sick.com)