



TMS88B-ACC360

TMS/TMM88

INCLINATION SENSORS

SICK
Sensor Intelligence.



Illustration may differ

Ordering information

Type	Part no.
TMS88B-ACC360	1073788

Other models and accessories → www.sick.com/TMS_TMM88



Detailed technical data

Performance

Number of axis	1
Measuring range	360°
Resolution	0.01°
Static measurement accuracy	Typ. ± 0.15°, max. ± 0.25°
Temperature coefficient (zero point)	Typ. ±0.008°/K ¹⁾
Limit frequency	0.1 Hz ... 25 Hz, 8. range (with digital filter)
Sampling rate	80 Hz

¹⁾ Referring to the temperature of 25 °C.

Interfaces

Communication interface	CANopen
Device profile	CiA DS-301, DS-410 v4.2.0 CiA (Device profile for inclination sensors) CiA DSP-305 (Layer Setting Service (LSS) and protocols)
Address setting	0...127, default: 10
Data transmission rate (baud rate)	10 kbit/s ... 1,000 kbit/s, Default: automatic baud rate detection
Status information	CANopen status via status LED
Bus termination	Via external terminator
Parameterising data	Zerose Limit frequency Preset value Inverting of counting direction
Programmable/configurable	Over PGT-12-Pro
Initialization time	80 ms

Electrical data

Connection type	Male connector, M12, 5-pin
Supply voltage	8 V DC ... 36 V DC
Current consumption	< 16 mA @ 24 V
Reverse polarity protection	✓
MTTFd: mean time to dangerous failure	663 years (EN ISO 13849-1) ¹⁾

¹⁾ This product is a standard product and does not constitute a safety component as defined in the Machinery Directive. Calculation based on nominal load of components, average ambient temperature 40°C, frequency of use 8760 h/a. All electronic failures are considered hazardous. For more information, see document no. 8015532.

Mechanical data

Dimensions	58 mm x 90 mm x 31 mm
Weight	200 g
Housing material	Aluminum

Ambient data

EMC	EN 61326-1, EN ISO 14982, EN ISO 13309
Enclosure rating	IP65 IP67
Operating temperature range	-40 °C ... +80 °C
Storage temperature range	-40 °C ... +85 °C
Resistance to shocks	100 g, 6 ms (according to EN 60068-2-27)
Resistance to vibration	10 g, 10 Hz ... 2,000 Hz (EN 60068-2-6)

Classifications

eCl@ss 5.0	27270790
eCl@ss 5.1.4	27270790
eCl@ss 6.0	27270790
eCl@ss 6.2	27270790
eCl@ss 7.0	27270790
eCl@ss 8.0	27270790
eCl@ss 8.1	27270790
eCl@ss 9.0	27270790
eCl@ss 10.0	27271101
eCl@ss 11.0	27271101
eCl@ss 12.0	27271101
ETIM 5.0	EC001852
ETIM 6.0	EC001852
ETIM 7.0	EC001852
ETIM 8.0	EC001852
UNSPSC 16.0901	41111613

Dimensional drawing (Dimensions in mm (inch))

TMx88B-AxC

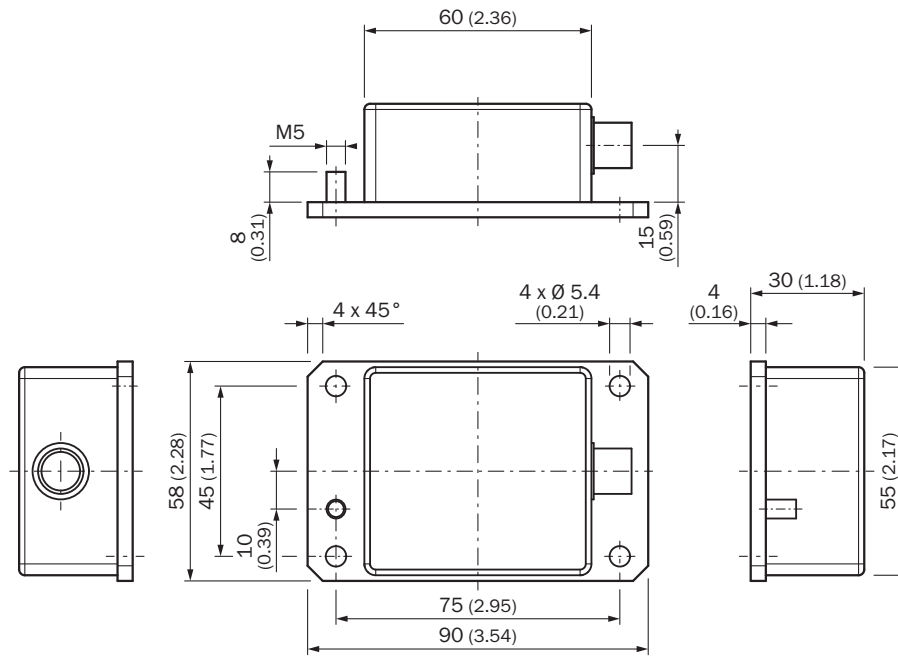



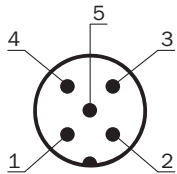

PIN assignment



PIN	Signal	Function
Male connector M12, 5-pin		
1	CAN Shield	Shielding
2	VDC	Supply voltage
3	GND/CAN GND	0V (GND)
4	CAN high	CAN signal
5	CAN low	CAN signal

Recommended accessories

Other models and accessories → www.sick.com/TMS_TMM88

	Brief description	Type	Part no.
Programming and configuration tools			
	Hand-held programming device for the programmable SICK AHS/AHM36 CANopen encoders, TMS/TMM61 CANopen inclination sensors, TMS/TMM88 CANopen, TMS/TMM88 Analog, and wire draw encoders with AHS/AHM36 CANopen. Compact dimensions, low weight, and intuitive operation.	PGT-12-Pro	1076313
Plug connectors and cables			
	Head A: female connector, M12, 5-pin, straight, A-coded Head B: Flying leads Cable: Fieldbus, CANopen, DeviceNet™, PUR, halogen-free, shielded, 2 m	YF2A15-020C1BXLEAX	2106283
	Head A: female connector, M12, 5-pin, straight, A-coded Head B: Flying leads Cable: Fieldbus, CANopen, DeviceNet™, PUR, halogen-free, shielded, 5 m	YF2A15-050C1BXLEAX	2106284
	Head A: female connector, M12, 5-pin, straight, A-coded Head B: Flying leads Cable: Fieldbus, CANopen, DeviceNet™, PUR, halogen-free, shielded, 10 m	YF2A15-100C1BXLEAX	2106286
	Head A: female connector, M12, 5-pin, straight, A-coded Head B: male connector, M12, 5-pin, straight, A-coded Cable: Fieldbus, CANopen, DeviceNet™, PUR, halogen-free, shielded, 2 m	YF2A15-020C1BM2A15	2106279
	Head A: female connector, M12, 5-pin, straight, A-coded Head B: male connector, M12, 5-pin, straight, A-coded Cable: Fieldbus, CANopen, DeviceNet™, PUR, halogen-free, shielded, 5 m	YF2A15-050C1BM2A15	2106281
	Head A: female connector, M12, 5-pin, straight, A-coded Head B: male connector, M12, 5-pin, straight, A-coded Cable: Fieldbus, CANopen, DeviceNet™, PUR, halogen-free, shielded, 10 m	YF2A15-100C1BM2A15	2106282
	Head A: female connector, M12, 5-pin, straight Cable: CANopen, DeviceNet™, shielded	DOS-1205-GA	6027534
	Head A: male connector, M12, 5-pin, straight, A-coded Cable: CANopen, DeviceNet™, shielded	STE-1205-GA	6027533

SICK AT A GLANCE

SICK is one of the leading manufacturers of intelligent sensors and sensor solutions for industrial applications. A unique range of products and services creates the perfect basis for controlling processes securely and efficiently, protecting individuals from accidents and preventing damage to the environment.

We have extensive experience in a wide range of industries and understand their processes and requirements. With intelligent sensors, we can deliver exactly what our customers need. In application centers in Europe, Asia and North America, system solutions are tested and optimized in accordance with customer specifications. All this makes us a reliable supplier and development partner.

Comprehensive services complete our offering: SICK LifeTime Services provide support throughout the machine life cycle and ensure safety and productivity.

For us, that is “Sensor Intelligence.”

WORLDWIDE PRESENCE:

Contacts and other locations –www.sick.com