

SRS50-HWA0-K21

SRS/SRM50

MOTOR FEEDBACK SYSTEMS ROTARY HIPERFACE®

SICK
Sensor Intelligence.

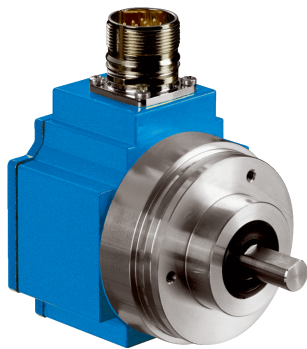

Illustration may differ



Ordering information

| Type | Part no. |
|----------------|----------|
| SRS50-HWA0-K21 | 1037091 |

Other models and accessories → www.sick.com/SRS_SRM50

Detailed technical data

Performance

| | |
|---|--|
| Sine/cosine periods per revolution | 1,024 |
| Number of the absolute ascertainable revolutions | 1 |
| Total number of steps | 32,768 |
| Measuring step | 0.3 " For interpolation of the sine/cosine signals with, e. g., 12 bits |
| Integral non-linearity | Typ. $\pm 45 "$, Error limits for evaluating sine/cosine period |
| Differential non-linearity | $\pm 7 "$ |
| Operating speed | $\leq 6,000 \text{ min}^{-1}$, up to which the absolute position can be reliably produced |
| Available memory area | 128 Byte |
| System accuracy | $\pm 52 "$ |

Interfaces

| | |
|--|---|
| Type of code for the absolute value | Binary |
| Code sequence | Increasing, when turning the shaft For clockwise rotation, looking in direction "A" (see dimensional drawing), For clockwise shaft rotation, looking in direction "A" (see dimensional drawing) |
| Communication interface | HIPERFACE® |

Electrical data

| | |
|---|--|
| Connection type | Male connector, M23, 12-pin, radial |
| Supply voltage | 7 V DC ... 12 V DC |
| Recommended supply voltage | 8 V DC |
| Current consumption | 80 mA ¹⁾ |
| Output frequency for sine/cosine signals | $\leq 200 \text{ kHz}$ |
| MTTF: mean time to dangerous failure | 235 years (EN ISO 13849) ²⁾ |

¹⁾ Without load.

²⁾ This product is a standard product and does not constitute a safety component as defined in the Machinery Directive. Calculation based on nominal load of components, average ambient temperature 60 °C, frequency of use 8760 h/a. All electronic failures are considered hazardous. For more information, see document no. 8015532.

Mechanical data

| | |
|---------------------------------------|------------------------------------|
| Shaft version | Solid shaft |
| Shaft diameter | 10 mm |
| Flange type / stator coupling | Face mount flange, stator coupling |
| Dimensions | See dimensional drawing |
| Weight | ≤ 0.2 kg |
| Moment of inertia of the rotor | 25 gcm ² |
| Operating speed | ≤ 12,000 min ⁻¹ |
| Angular acceleration | ≤ 200,000 rad/s ² |
| Operating torque | 1 Ncm |
| Start up torque | + 1.5 Ncm |
| Permissible shaft loading | 40 N (radial) 20 N (axial) |
| Life of ball bearings | 3.6 x 10 ⁹ revolutions |

Ambient data

| | |
|--|--|
| Operating temperature range | -30 °C ... +85 °C |
| Storage temperature range | -30 °C ... +90 °C, without package |
| Relative humidity/condensation | 90 %, Condensation not permitted |
| Resistance to shocks | 100 g, 10 ms, 10 ms (according to EN 60068-2-27) |
| Frequency range of resistance to vibrations | 20 g, 10 Hz ... 2,000 Hz (EN 60068-2-6) |
| EMC | According to EN 61000-6-2 and EN 61000-6-3 ¹⁾ |
| Enclosure rating | IP65, with mating connector inserted (IEC 60529) |

¹⁾ The EMC according to the standards quoted is achieved when the motor feedback system is mounted in an electrically conductive housing, which is connected to the central earthing point of the motor controller via a cable screen. The GND-(0 V) connection of the supply voltage is also grounded here. If other shielding concepts are used, users must perform their own tests.

Classifications

| | |
|-----------------------|----------|
| eCl@ss 5.0 | 27270590 |
| eCl@ss 5.1.4 | 27270590 |
| eCl@ss 6.0 | 27270590 |
| eCl@ss 6.2 | 27270590 |
| eCl@ss 7.0 | 27270590 |
| eCl@ss 8.0 | 27270590 |
| eCl@ss 8.1 | 27270590 |
| eCl@ss 9.0 | 27270590 |
| eCl@ss 10.0 | 27273805 |
| eCl@ss 11.0 | 27273901 |
| eCl@ss 12.0 | 27273901 |
| ETIM 5.0 | EC001486 |
| ETIM 6.0 | EC001486 |
| ETIM 7.0 | EC001486 |
| ETIM 8.0 | EC001486 |
| UNSPSC 16.0901 | 41112113 |

Dimensional drawing (Dimensions in mm (inch))

Solid shaft, servo flange, stand-alone

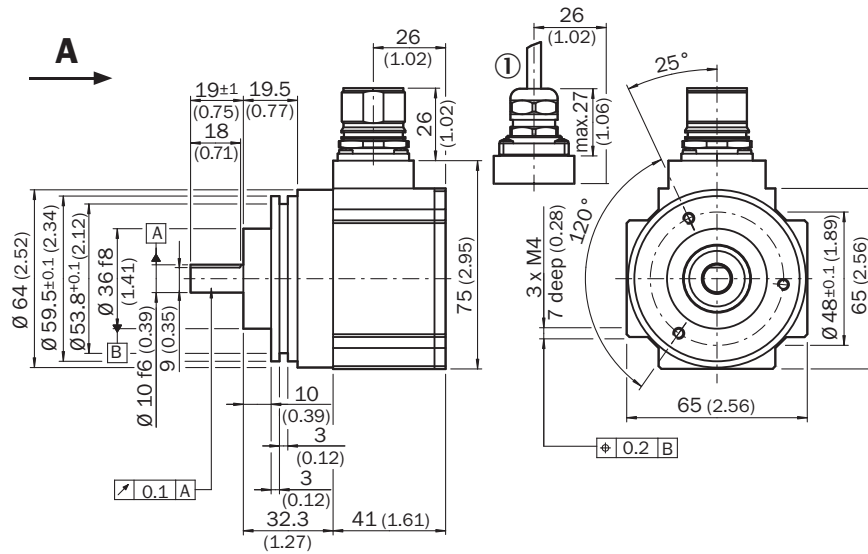

General tolerances according to ISO 2768-mk

① R = min. bending radius 40 mm

PIN assignment

View of the M23 male connector plug-in face

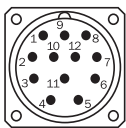
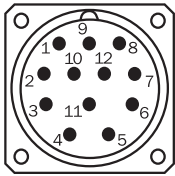

Ansicht Steckseite

Schirmanschluss am Steckergehäuse

N. C. = Not connected

Diagrams

Signal specification of the process channel

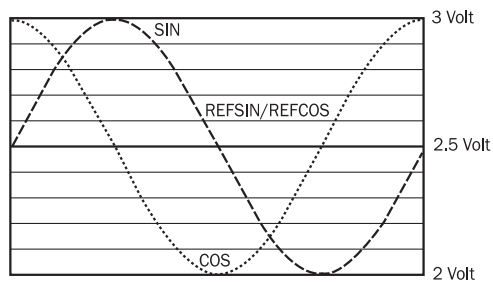

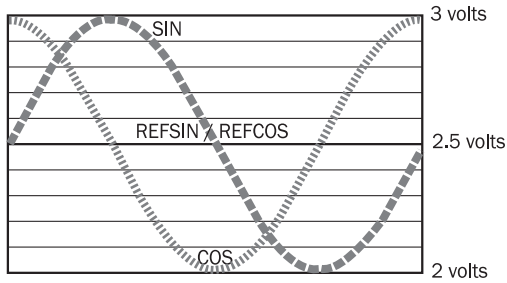

Signal diagram for clockwise rotation of the shaft looking in direction "A" (see dimensional drawing) 1 period = 360° : 1024

Signal diagram for clockwise rotation of the shaft looking in direction "A" (see dimensional drawing) 1 period = 360 ° : 1024



Recommended accessories

Other models and accessories → www.sick.com/SRS_SRM50

| | Brief description | Type | Part no. |
|---|--|------------------|----------|
| Programming and configuration tools | | | |
|  | SVip® LAN programming tool for all motor feedback systems | PGT-11-S LAN | 1057324 |
| Spare parts | | | |
| | BEF-MK-S02 | BEF-MK-S02 | 2074582 |
| Plug connectors and cables | | | |
|  | Head A: female connector, M23, 12-pin, straight Head B: Flying leads Cable: HIPERFACE®, PUR, halogen-free, shielded, 3 m | DOL-2308-G03MJB2 | 2031070 |
| | Head A: female connector, M23, 12-pin, straight Head B: Flying leads Cable: HIPERFACE®, PUR, halogen-free, shielded, 5 m | DOL-2308-G05MJB2 | 2031071 |
| | Head A: female connector, M23, 12-pin, straight Head B: Flying leads Cable: HIPERFACE®, PUR, halogen-free, shielded, 10 m | DOL-2308-G10MJB2 | 2031072 |
| | Head A: female connector, M23, 12-pin, straight Head B: Flying leads Cable: HIPERFACE®, PUR, halogen-free, shielded, 15 m | DOL-2308-G15MJB2 | 2031073 |
| | Head A: female connector, M23, 12-pin, straight Head B: Flying leads Cable: HIPERFACE®, PUR, halogen-free, shielded, 1.5 m | DOL-2308-G1M5JB2 | 2031069 |

SICK AT A GLANCE

SICK is one of the leading manufacturers of intelligent sensors and sensor solutions for industrial applications. A unique range of products and services creates the perfect basis for controlling processes securely and efficiently, protecting individuals from accidents and preventing damage to the environment.

We have extensive experience in a wide range of industries and understand their processes and requirements. With intelligent sensors, we can deliver exactly what our customers need. In application centers in Europe, Asia and North America, system solutions are tested and optimized in accordance with customer specifications. All this makes us a reliable supplier and development partner.

Comprehensive services complete our offering: SICK LifeTime Services provide support throughout the machine life cycle and ensure safety and productivity.

For us, that is “Sensor Intelligence.”

WORLDWIDE PRESENCE:

Contacts and other locations –www.sick.com