



# DKV60-E2K02000

DKV60

MEASURING WHEEL ENCODERS

**SICK**  
Sensor Intelligence.



Illustration may differ



### Ordering information

Type	Part no.
DKV60-E2K02000	1035054

Other models and accessories → [www.sick.com/DKV60](http://www.sick.com/DKV60)

### Detailed technical data

#### Performance

<b>Pulses per revolution</b>	2,000
<b>Resolution in pulses/mm</b>	10
<b>Measuring increment (resolution in mm/pulse)</b>	0.1
<b>Error limits</b>	± 4 mm/m, subject to the measuring wheel (wheel + surface)
<b>Initialization time</b>	40 s

#### Interfaces

<b>Communication interface</b>	Incremental
<b>Communication Interface detail</b>	HTL / Push pull

#### Electrical data

<b>Connection type</b>	Cable, 8-wire, universal, 1.5 m
<b>Supply voltage</b>	10 V ... 30 V
<b>Load current max.</b>	30 mA
<b>Maximum output frequency</b>	≤ 200 kHz
<b>Reference signal, number</b>	1
<b>Reference signal, position</b>	90°, electric, logically gated with A and B
<b>Reverse polarity protection</b>	-

#### Mechanical data

<b>Measuring wheel circumference</b>	200 mm
<b>Measuring wheel surface</b>	O ring EPDM <sup>1)</sup>
<b>Spring arm design</b>	69.5 mm spring arm
<b>Mass</b>	420 g
<b>Encoder material</b>	
Shaft	Stainless steel
Flange	Zinc cast
Housing	Zinc cast
Cable	PUR

<sup>1)</sup> The surface of a measuring wheel is subject to wear. This depends on contact pressure, acceleration behavior in the application, traversing speed, measurement surface, mechanical alignment of the measuring wheel, temperature, and ambient conditions. We recommend you regularly check the condition of the measuring wheel and replace as required.

<sup>2)</sup> When measured from the top of the measuring surface.

<b>Spring arm mechanism material</b>	
Spring element	Spring steel, anti-corrosive
Measuring wheel, spring arm	Aluminum
<b>Start up torque</b>	0.6 Ncm (at 20 °C)
<b>Operating torque</b>	0.4 Ncm (at 20 °C)
<b>Operating speed</b>	≤ 1,000 min <sup>-1</sup>
<b>Maximum operating speed</b>	1,500 min <sup>-1</sup>
<b>Bearing lifetime</b>	2 x 10 <sup>9</sup> revolutions
<b>Maximum travel/deflection of spring arm</b>	8 mm at 14 N spring travel
<b>Recommended pretension</b>	8 N at 4 mm deflection <sup>2)</sup>
<b>Max. permissible working area for the spring (continuous operation)</b>	± 1.5 mm
<b>Recommended spring deflection</b>	2 mm ... 8 mm

<sup>1)</sup> The surface of a measuring wheel is subject to wear. This depends on contact pressure, acceleration behavior in the application, traversing speed, measurement surface, mechanical alignment of the measuring wheel, temperature, and ambient conditions. We recommend you regularly check the condition of the measuring wheel and replace as required.

<sup>2)</sup> When measured from the top of the measuring surface.

#### Ambient data

<b>EMC</b>	EN 61000-6-3
<b>Enclosure rating</b>	IP65
<b>Operating temperature range</b>	-10 °C ... +60 °C
<b>Storage temperature range</b>	-40 °C ... +70 °C, without package

#### Classifications

<b>ECLASS 5.0</b>	27270501
<b>ECLASS 5.1.4</b>	27270501
<b>ECLASS 6.0</b>	27270590
<b>ECLASS 6.2</b>	27270590
<b>ECLASS 7.0</b>	27270501
<b>ECLASS 8.0</b>	27270501
<b>ECLASS 8.1</b>	27270501
<b>ECLASS 9.0</b>	27270501
<b>ECLASS 10.0</b>	27270790
<b>ECLASS 11.0</b>	27270707
<b>ECLASS 12.0</b>	27270504
<b>ETIM 5.0</b>	EC001486
<b>ETIM 6.0</b>	EC001486
<b>ETIM 7.0</b>	EC001486
<b>ETIM 8.0</b>	EC001486
<b>UNSPSC 16.0901</b>	41112113

**Dimensional drawing** (Dimensions in mm (inch))

Measuring drum, O-ring surface

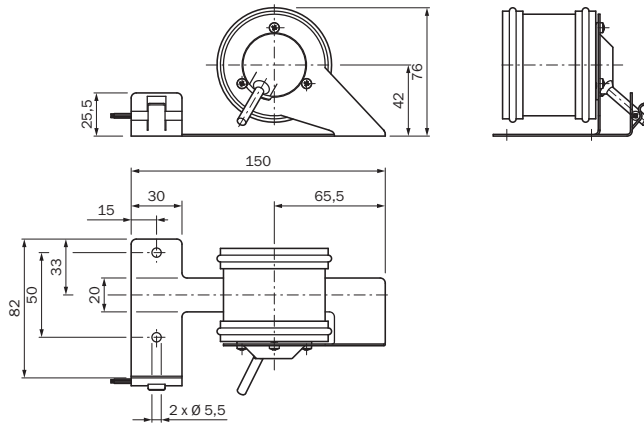

**PIN assignment**

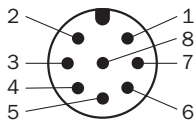

View of M12 male device connector on cable / housing



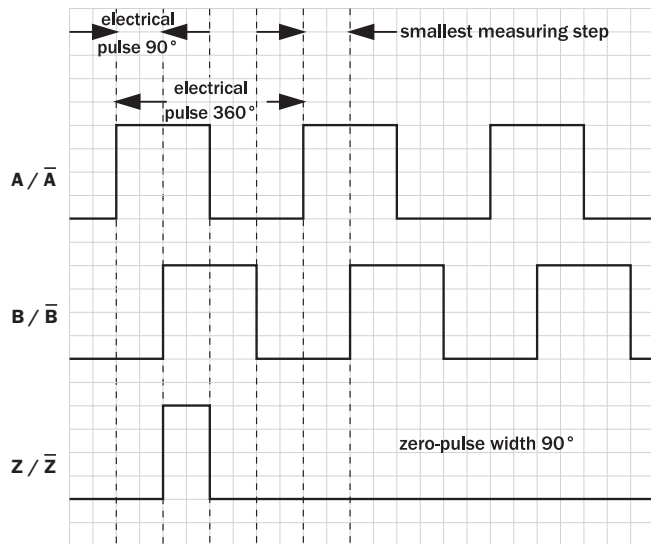

Wire colors (cable connection)	Male connector M12, 8-pin	TTL/HTL 6-channel signal	Explanation
Brown	1	A-	Signal cable
White	2	A	Signal cable
Black	3	B-	Signal cable
Pink	4	B	Signal cable
Yellow	5	Z-	Signal cable
Purple	6	Z	Signal cable
Blue	7	GND	Ground connection
Red	8	+U <sub>s</sub>	Supply voltage
Screen	Screen	Screen	Screen connected to encoder housing









## Diagrams













## Recommended accessories

Other models and accessories → [www.sick.com/DKV60](http://www.sick.com/DKV60)

	Brief description	Type	Part no.
Others			
	<ul style="list-style-type: none"> <li><b>Connection type head A:</b> Female connector, JST, 8-pin, straight</li> <li><b>Connection type head B:</b> Flying leads</li> <li><b>Signal type:</b> Incremental, SSI</li> <li><b>Items supplied:</b> JST including sealing</li> <li><b>Cable:</b> 0.5 m, 8-wire, PUR, halogen-free</li> <li><b>Description:</b> Incremental, SSI, shielded, Head A: female connector, JST, 8-pin, straight Head B: cable Cable: incremental, suitable for drag chain, PUR, halogen-free, shielded, 4 x 2 x 0.15 mm<sup>2</sup>, Ø 5.6 mm</li> </ul>	DOL-0J08-G0M5AA3	2046873
	<ul style="list-style-type: none"> <li><b>Connection type head A:</b> Female connector, JST, 8-pin, straight</li> <li><b>Connection type head B:</b> Flying leads</li> <li><b>Signal type:</b> Incremental</li> <li><b>Items supplied:</b> JST including sealing</li> <li><b>Cable:</b> 1.5 m, 8-wire, PUR, halogen-free</li> <li><b>Description:</b> Incremental, shielded, Head A: female connector, JST, 8-pin, straight Head B: cable Cable: incremental, suitable for drag chain, PUR, halogen-free, shielded, 4 x 2 x 0.15 mm<sup>2</sup>, Ø 5.6 mm</li> </ul>	DOL-0J08-G1M5AA3	2046874
	<ul style="list-style-type: none"> <li><b>Connection type head A:</b> Female connector, JST, 8-pin, straight</li> <li><b>Connection type head B:</b> Flying leads</li> <li><b>Signal type:</b> SSI, Incremental</li> <li><b>Items supplied:</b> JST including sealing</li> <li><b>Cable:</b> 1.5 m, 8-wire, PUR, halogen-free</li> <li><b>Description:</b> SSI, Incremental, shielded</li> </ul>	DOL-0J08-G1M5AA6	2048590
	<ul style="list-style-type: none"> <li><b>Connection type head A:</b> Female connector, JST, 8-pin, straight</li> <li><b>Connection type head B:</b> Flying leads</li> <li><b>Signal type:</b> Incremental, SSI</li> <li><b>Items supplied:</b> JST including sealing</li> <li><b>Cable:</b> 10 m, 8-wire, PUR, halogen-free</li> <li><b>Description:</b> Incremental, SSI, shielded, Head A: female connector, JST, 8-pin, straight Head B: cable Cable: incremental, suitable for drag chain, PUR, halogen-free, shielded, 4 x 2 x 0.15 mm<sup>2</sup>, Ø 5.6 mm</li> </ul>	DOL-0J08-G10MAA3	2046877

	Brief description	Type	Part no.
	<ul style="list-style-type: none"> <li><b>Connection type head A:</b> Female connector, JST, 8-pin, straight</li> <li><b>Connection type head B:</b> Flying leads</li> <li><b>Signal type:</b> SSI, Incremental</li> <li><b>Items supplied:</b> JST including sealing</li> <li><b>Cable:</b> 3 m, 8-wire, PUR, halogen-free</li> <li><b>Description:</b> SSI, Incremental, shielded</li> </ul>	DOL-0J08-G3M0AA6	2048591
	<ul style="list-style-type: none"> <li><b>Connection type head A:</b> Female connector, M12, 8-pin, straight</li> <li><b>Connection type head B:</b> Flying leads</li> <li><b>Signal type:</b> Incremental, SSI</li> <li><b>Cable:</b> 2 m, 8-wire, PUR, halogen-free</li> <li><b>Description:</b> Incremental, SSI, shielded, Head A: female connector, M12, 8-pin, straight Head B: cable Cable: suitable for drag chain, PVC, shielded, 4 x 2 x 0.25 mm<sup>2</sup>, Ø 7.0 mm</li> <li><b>Connection systems:</b> Flying leads</li> </ul>	DOL-1208-G02MAC1	6032866
	<ul style="list-style-type: none"> <li><b>Connection type head A:</b> Female connector, M12, 8-pin, straight</li> <li><b>Connection type head B:</b> Flying leads</li> <li><b>Signal type:</b> Incremental, SSI</li> <li><b>Cable:</b> 5 m, 8-wire, PUR, halogen-free</li> <li><b>Description:</b> Incremental, SSI, shielded, Head A: female connector, M12, 8-pin, straight Head B: cable Cable: suitable for drag chain, PVC, shielded, 4 x 2 x 0.25 mm<sup>2</sup>, Ø 7.0 mm</li> <li><b>Connection systems:</b> Flying leads</li> </ul>	DOL-1208-G05MAC1	6032867
	<ul style="list-style-type: none"> <li><b>Connection type head A:</b> Female connector, M12, 8-pin, straight</li> <li><b>Connection type head B:</b> Flying leads</li> <li><b>Signal type:</b> Incremental, SSI</li> <li><b>Cable:</b> 10 m, 8-wire, PUR, halogen-free</li> <li><b>Description:</b> Incremental, SSI, shielded, Head A: female connector, M12, 8-pin, straight Head B: cable Cable: suitable for drag chain, PVC, shielded, 4 x 2 x 0.25 mm<sup>2</sup>, Ø 7.0 mm</li> <li><b>Connection systems:</b> Flying leads</li> </ul>	DOL-1208-G10MAC1	6032868
	<ul style="list-style-type: none"> <li><b>Connection type head A:</b> Female connector, M12, 8-pin, straight</li> <li><b>Connection type head B:</b> Flying leads</li> <li><b>Signal type:</b> Incremental, SSI</li> <li><b>Cable:</b> 20 m, 8-wire, PUR, halogen-free</li> <li><b>Description:</b> Incremental, SSI, shielded, Head A: female connector, M12, 8-pin, straight Head B: cable Cable: suitable for drag chain, PVC, shielded, 4 x 2 x 0.25 mm<sup>2</sup>, Ø 7.0 mm</li> <li><b>Connection systems:</b> Flying leads</li> </ul>	DOL-1208-G20MAC1	6032869
	<ul style="list-style-type: none"> <li><b>Connection type head A:</b> Female connector, M12, 8-pin, straight</li> <li><b>Connection type head B:</b> Flying leads</li> <li><b>Signal type:</b> Incremental, SSI</li> <li><b>Cable:</b> 25 m, 8-wire, PUR, halogen-free</li> <li><b>Description:</b> Incremental, SSI, shielded, Head A: female connector, M12, 8-pin, straight Head B: cable Cable: suitable for drag chain, PVC, shielded, 4 x 2 x 0.25 mm<sup>2</sup>, Ø 7.0 mm</li> <li><b>Connection systems:</b> Flying leads</li> </ul>	DOL-1208-G25MAC1	6067859
	<ul style="list-style-type: none"> <li><b>Connection type head A:</b> Female connector, M23, 12-pin, straight</li> <li><b>Connection type head B:</b> Flying leads</li> <li><b>Signal type:</b> Incremental</li> <li><b>Cable:</b> 2 m, 11-wire, PUR</li> <li><b>Description:</b> Incremental, shielded, Head A: female connector, M23, 12-pin, straight Head B: cable Cable: incremental, PUR, shielded, 4 x 2 x 0.25 mm<sup>2</sup> + 2 x 0.5 mm<sup>2</sup> + 1 x 0.14 mm<sup>2</sup>, Ø 7.8 mm</li> </ul>	DOL-2312-G02MLA3	2030682
	<ul style="list-style-type: none"> <li><b>Connection type head A:</b> Female connector, M23, 12-pin, straight</li> <li><b>Connection type head B:</b> Flying leads</li> <li><b>Signal type:</b> Incremental</li> <li><b>Cable:</b> 3 m, 12-wire, PUR, halogen-free</li> <li><b>Description:</b> Incremental, shielded, Head A: female connector, M23, 12-pin, straight Head B: Cable Cable: incremental, suitable for drag chain, PUR, halogen-free, shielded, 4 x 2 x 0.25 mm<sup>2</sup> + 2 x 0.5 mm<sup>2</sup> + 1 x 0.14 mm<sup>2</sup>, Ø 7.8 mm</li> </ul>	DOL-2312-G03MMA3	2029213

	Brief description	Type	Part no.
	<ul style="list-style-type: none"> <li>• <b>Connection type head A:</b> Female connector, M23, 12-pin, straight</li> <li>• <b>Connection type head B:</b> Flying leads</li> <li>• <b>Signal type:</b> Incremental</li> <li>• <b>Cable:</b> 5 m, 12-wire, PUR, halogen-free</li> <li>• <b>Description:</b> Incremental, shielded, Head A: female connector, M23, 12-pin, straight Head B: Cable Cable: incremental, suitable for drag chain, PUR, halogen-free, shielded, 4 x 2 x 0.25 mm<sup>2</sup> + 2 x 0.5 mm<sup>2</sup> + 1 x 0.14 mm<sup>2</sup>, Ø 7.8 mm</li> </ul>	DOL-2312-G05MMA3	2029214
	<ul style="list-style-type: none"> <li>• <b>Connection type head A:</b> Female connector, M23, 12-pin, straight</li> <li>• <b>Connection type head B:</b> Flying leads</li> <li>• <b>Signal type:</b> Incremental</li> <li>• <b>Cable:</b> 7 m, 11-wire, PUR</li> <li>• <b>Description:</b> Incremental, shielded, Head A: female connector, M23, 12-pin, straight Head B: cable Cable: incremental, PUR, shielded, 4 x 2 x 0.25 mm<sup>2</sup> + 2 x 0.5 mm<sup>2</sup> + 1 x 0.14 mm<sup>2</sup>, Ø 7.8 mm</li> </ul>	DOL-2312-G07MLA3	2030685
	<ul style="list-style-type: none"> <li>• <b>Connection type head A:</b> Female connector, M23, 12-pin, straight</li> <li>• <b>Connection type head B:</b> Flying leads</li> <li>• <b>Signal type:</b> Incremental</li> <li>• <b>Cable:</b> 1.5 m, 12-wire, PUR, halogen-free</li> <li>• <b>Description:</b> Incremental, shielded, Head A: female connector, M23, 12-pin, straight Head B: Cable Cable: incremental, suitable for drag chain, PUR, halogen-free, shielded, 4 x 2 x 0.25 mm<sup>2</sup> + 2 x 0.5 mm<sup>2</sup> + 1 x 0.14 mm<sup>2</sup>, Ø 7.8 mm</li> </ul>	DOL-2312-G1M5MA3	2029212
	<ul style="list-style-type: none"> <li>• <b>Connection type head A:</b> Female connector, M23, 12-pin, straight</li> <li>• <b>Connection type head B:</b> Flying leads</li> <li>• <b>Signal type:</b> Incremental</li> <li>• <b>Cable:</b> 10 m, 11-wire, PUR</li> <li>• <b>Description:</b> Incremental, shielded, Head A: female connector, M23, 12-pin, straight Head B: cable Cable: incremental, PUR, shielded, 4 x 2 x 0.25 mm<sup>2</sup> + 2 x 0.5 mm<sup>2</sup> + 1 x 0.14 mm<sup>2</sup>, Ø 7.8 mm</li> </ul>	DOL-2312-G10MLA3	2030688
	<ul style="list-style-type: none"> <li>• <b>Connection type head A:</b> Female connector, M23, 12-pin, straight</li> <li>• <b>Connection type head B:</b> Flying leads</li> <li>• <b>Signal type:</b> Incremental</li> <li>• <b>Cable:</b> 10 m, 12-wire, PUR, halogen-free</li> <li>• <b>Description:</b> Incremental, shielded, Head A: female connector, M23, 12-pin, straight Head B: Cable Cable: incremental, suitable for drag chain, PUR, halogen-free, shielded, 4 x 2 x 0.25 mm<sup>2</sup> + 2 x 0.5 mm<sup>2</sup> + 1 x 0.14 mm<sup>2</sup>, Ø 7.8 mm</li> </ul>	DOL-2312-G10MMA3	2029215
	<ul style="list-style-type: none"> <li>• <b>Connection type head A:</b> Female connector, M23, 12-pin, straight</li> <li>• <b>Connection type head B:</b> Flying leads</li> <li>• <b>Signal type:</b> Incremental</li> <li>• <b>Cable:</b> 15 m, 11-wire, PUR</li> <li>• <b>Description:</b> Incremental, shielded, Head A: female connector, M23, 12-pin, straight Head B: cable Cable: incremental, PUR, shielded, 4 x 2 x 0.25 mm<sup>2</sup> + 2 x 0.5 mm<sup>2</sup> + 1 x 0.14 mm<sup>2</sup>, Ø 7.8 mm</li> </ul>	DOL-2312-G15MLA3	2030692
	<ul style="list-style-type: none"> <li>• <b>Connection type head A:</b> Female connector, M23, 12-pin, straight</li> <li>• <b>Connection type head B:</b> Flying leads</li> <li>• <b>Signal type:</b> Incremental</li> <li>• <b>Cable:</b> 20 m, 11-wire, PUR</li> <li>• <b>Description:</b> Incremental, shielded, Head A: female connector, M23, 12-pin, straight Head B: cable Cable: incremental, PUR, shielded, 4 x 2 x 0.25 mm<sup>2</sup> + 2 x 0.5 mm<sup>2</sup> + 1 x 0.14 mm<sup>2</sup>, Ø 7.8 mm</li> </ul>	DOL-2312-G20MLA3	2030695
	<ul style="list-style-type: none"> <li>• <b>Connection type head A:</b> Female connector, M23, 12-pin, straight</li> <li>• <b>Connection type head B:</b> Flying leads</li> <li>• <b>Signal type:</b> Incremental</li> <li>• <b>Cable:</b> 20 m, 12-wire, PUR, halogen-free</li> <li>• <b>Description:</b> Incremental, shielded, Head A: Female connector, M23, 12-pin, straight Head B: Cable Cable: Incremental, suitable for drag chain, PUR, halogen-free, shielded, 4 x 2 x 0.25 mm<sup>2</sup> + 2 x 0.5 mm<sup>2</sup> + 1 x 0.14 mm<sup>2</sup>, Ø 7.8 mm</li> </ul>	DOL-2312-G20MMA3	2029216

	Brief description	Type	Part no.
	<ul style="list-style-type: none"> <li>• <b>Connection type head A:</b> Female connector, M23, 12-pin, straight</li> <li>• <b>Connection type head B:</b> Flying leads</li> <li>• <b>Signal type:</b> Incremental</li> <li>• <b>Cable:</b> 25 m, 11-wire, PUR</li> <li>• <b>Description:</b> Incremental, shielded, Head A: female connector, M23, 12-pin, straight Head B: cable Cable: incremental, PUR, shielded, 4 x 2 x 0.25 mm<sup>2</sup> + 2 x 0.5 mm<sup>2</sup> + 1 x 0.14 mm<sup>2</sup>, Ø 7.8 mm</li> </ul>	DOL-2312-G25MLA3	2030699
	<ul style="list-style-type: none"> <li>• <b>Connection type head A:</b> Female connector, M23, 12-pin, straight</li> <li>• <b>Connection type head B:</b> Flying leads</li> <li>• <b>Signal type:</b> Incremental</li> <li>• <b>Cable:</b> 30 m, 11-wire, PUR</li> <li>• <b>Description:</b> Incremental, shielded, Head A: female connector, M23, 12-pin, straight Head B: cable Cable: incremental, PUR, shielded, 4 x 2 x 0.25 mm<sup>2</sup> + 2 x 0.5 mm<sup>2</sup> + 1 x 0.14 mm<sup>2</sup>, Ø 7.8 mm</li> </ul>	DOL-2312-G30MLA3	2030702
	<ul style="list-style-type: none"> <li>• <b>Connection type head A:</b> Female connector, M23, 12-pin, straight</li> <li>• <b>Connection type head B:</b> Flying leads</li> <li>• <b>Signal type:</b> Incremental</li> <li>• <b>Cable:</b> 30 m, 12-wire, PUR, halogen-free</li> <li>• <b>Description:</b> Incremental, shielded, Head A: female connector, M23, 12-pin, straight Head B: Cable Cable: incremental, suitable for drag chain, PUR, halogen-free, shielded, 4 x 2 x 0.25 mm<sup>2</sup> + 2 x 0.5 mm<sup>2</sup> + 1 x 0.14 mm<sup>2</sup>, Ø 7.8 mm</li> </ul>	DOL-2312-G30MMA3	2029217



## SICK AT A GLANCE

SICK is one of the leading manufacturers of intelligent sensors and sensor solutions for industrial applications. A unique range of products and services creates the perfect basis for controlling processes securely and efficiently, protecting individuals from accidents and preventing damage to the environment.

We have extensive experience in a wide range of industries and understand their processes and requirements. With intelligent sensors, we can deliver exactly what our customers need. In application centers in Europe, Asia and North America, system solutions are tested and optimized in accordance with customer specifications. All this makes us a reliable supplier and development partner.

Comprehensive services complete our offering: SICK LifeTime Services provide support throughout the machine life cycle and ensure safety and productivity.

For us, that is “Sensor Intelligence.”

## WORLDWIDE PRESENCE:

Contacts and other locations –[www.sick.com](http://www.sick.com)