



MICS3-CCAZ90AA1P01

Safe EFI-pro System

SAFETY SYSTEMS FOR AGVS AND AMRS

SICK
Sensor Intelligence.



Illustration may differ



Ordering information

Integration in the control system	Sub product family	Protective field range	Number of fields	Number of monitoring cases	Connection type	Type	Part no.
Local inputs and outputs (I/O), EFI-pro	microScan3 Pro I/O - EFI-pro	9 m	128	128	M12	MICS3-CCAZ90AA1P0	1110037

The system plug is pre-assembled on the underside. It can either be mounted on the rear side or the underside.

Other models and accessories → www.sick.com/Safe_EFI-pro_System

Detailed technical data

Features

Sub product family	microScan3 Pro I/O - EFI-pro
Model	Sensor including system plug (pre-mounted on the underside)
Application	Indoor
Protective field range	9 m
Warning field range	64 m
Collision protection field range	19 m (on reference target)
Number of simultaneously monitored fields	≤ 4 ¹⁾
Number of fields	128
Number of monitoring cases	128
Scanning angle	275°
Resolution (can be configured)	30 mm 40 mm 50 mm 60 mm 70 mm 150 mm 200 mm
Angular resolution	0.1°
Response time	≥ 90 ms
Protective field supplement	100 mm

¹⁾ Protection, warning or contour detection fields.

Safety-related parameters

Type	Type 3 (IEC 61496)
Safety integrity level	SIL 2 (IEC 61508)
Category	Category 3 (EN ISO 13849)

Performance level	PL d (EN ISO 13849)
PFH_D (mean probability of a dangerous failure per hour)	8.0 x 10 ⁻⁸
T_M (mission time)	20 years (EN ISO 13849)
Safe state in the event of a fault	At least one OSSD is in the OFF state. The safety outputs via the network are logic 0.

Functions

Restart interlock	✓
External device monitoring (EDM)	✓
Multiple sampling	✓
Monitoring case switching	✓
Simultaneous monitoring	✓
Static protective field switching	✓
Collision protection field	✓
Safe contour detection	✓
Contour as a reference	✓
Integrated configuration memory	✓
Measured data output	Via Ethernet
Safe SICK device communication via EFI-pro	✓

Interfaces

Connection type	
Voltage supply	1 x male connector, M12, 4-pin, A-coded
Local inputs and outputs (I/O)	2 x female connector, M12, 17-pin, A-coded
Dynamic switching signals	2 x female connector, M12, 8-pin, A-coded
Fieldbus, industrial network	2 x M12 female connectors, 4-pin, D-coded
Outputs	
OSSD pairs	4
Safety outputs via network	4
Universal outputs	4 ¹⁾
Inputs	
Universal inputs	≤ 16 ¹⁾
Dynamic switching signals	2
Static control inputs	≤ 8
Configuration method	PC with Safety Designer (Configuration and Diagnostic Software)
Configuration and diagnostics interface	USB 2.0, Mini-USB, Ethernet
Data interface	
Services	EtherNet/IP™ CIP Safety™ CoLa 2 (configuration and diagnostics using Safety Designer) Data output DHCP SNMP SNTP (client and server)

¹⁾ Freely configurable.

Fieldbus, industrial network	EFI-pro
RPI (requested packet interval)	5 ms ... 1,000 ms, multiple of 5 ms
Display elements	Graphic color display, LEDs

¹⁾ Freely configurable.

Electrical data

Protection class	III (EN 61140)
Supply voltage V_s	24 V DC (16.8 V DC ... 30 V DC)
Power consumption typical	8.1 W (without output load)

Mechanical data

Dimensions (W x H x D)	112 mm x 163 mm x 111.1 mm
Weight	1.6 kg
Housing material	Aluminum
Housing color	RAL 1021 (yellow), RAL 9005 (black)
Optics cover material	Polycarbonate
Optics cover surface finish	Outside with scratch-resistant coating

Ambient data

Enclosure rating	IP65 (IEC 60529)
Ambient light immunity	≤ 3,000 lx (IEC 61496-3)
Ambient operating temperature	-10 °C ... +50 °C
Storage temperature	-25 °C ... +70 °C
Vibration resistance	IEC 60068-2-6, IEC 60068-2-64, IEC 60721-3-5, IEC TR 60721-4-3, IEC 61496-1, IEC 61496-3
Class	5M1 (IEC 60721-3-5) 3M4 (IEC TR 60721-4-3)
Shock resistance	IEC 60068-2-27, IEC 60721-3-5, IEC TR 60721-4-3, IEC 61496-1, IEC 61496-3
Class	5M1 (IEC 60721-3-5) 3M4 (IEC TR 60721-4-3)
Continuous shock	100 m/s ² , 16 ms 150 m/s ² , 6 ms
EMC	IEC 61496-1, IEC 61000-6-2, IEC 61000-6-4

Other information

Type of light	Pulsed laser diode
Wave length	845 nm
Detectable remission factor	1.8% to several 1000%
Laser class	1M (21 CFR 1040.10 and 1040.11, IEC 60825-1)

Classifications

ECLASS 5.0	27272705
ECLASS 5.1.4	27272705
ECLASS 6.0	27272705
ECLASS 6.2	27272705
ECLASS 7.0	27272705
ECLASS 8.0	27272705

ECLASS 8.1	27272705
ECLASS 9.0	27272705
ECLASS 10.0	27272705
ECLASS 11.0	27272705
ECLASS 12.0	27272705
ETIM 5.0	EC002550
ETIM 6.0	EC002550
ETIM 7.0	EC002550
ETIM 8.0	EC002550
UNSPSC 16.0901	39121528

Dimensional drawing (Dimensions in mm (inch))

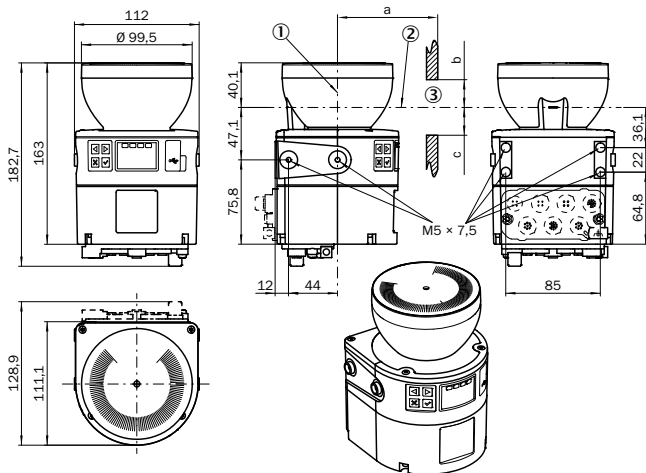

① Mirror axis of rotation

② Scan plane

③ Required viewing slit (a: length of the viewing slit, b: minimum height above the scan plane, c: minimum height below the scan plane. See the operating instructions for details.)

Pinouts

Ethernet (XF1, XF2)

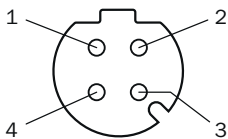

Pin	Designation	Description
1	TX+	Send data +
2	RX+	Receive data +
3	TX-	Send data -
4	RX-	Receive data -
Thread	SH	Shielding

Pin	Designation	Description
For details see operating instructions		

Voltage supply (XD1)

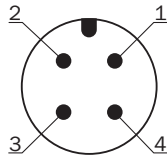

Pin	Designation	Description
1	+24 V DC	Supply voltage +24 V DC
2	n.c.	Not connected
3	0 V DC	Supply voltage 0 V DC
4	FE	Functional earth/shielding
For details see operating instructions		

Local inputs and outputs (XG1)

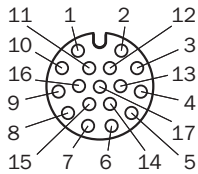

Pin	Designation	Description
1	OSSD 1.A	OSSD pair 1, OSSD A
2	OSSD 1.B	OSSD pair 1, OSSD B
3	OSSD 2.A	OSSD pair 2, OSSD A
4	OSSD 2.B	OSSD pair 2, OSSD B
5	Uni-I 01	Universal input 1, configurable
6	Uni-I 02	Universal input 2, configurable
7	Uni-I 03	Universal input 3, configurable
8	Uni-I 04	Universal input 4, configurable
9	Uni-I 05	Universal input 5, configurable
10	Uni-I 06	Universal input 6, configurable
11	Uni-I 07	Universal input 7, configurable
12	Uni-I 08	Universal input 8, configurable
13	Uni-I 09	Universal input 9, configurable
14	Uni-I 10	Universal input 10, configurable
15	Uni-O 01	Universal output 1
16	Uni-O 02	Universal output 2
17	0 V DC	Voltage for inputs and outputs (0 V DC) *

* If at least one connection of the female connector is used, this 0 V connection must be connected in the control cabinet to 0 V DC of the power supply unit using a low-impedance and star-point connection.

For details see operating instructions

Local inputs and outputs (XG4)

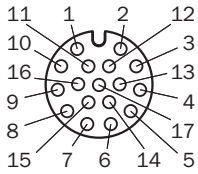

Pin	Designation	Description
1	OSSD 3.A	OSSD pair 3, OSSD A
2	OSSD 3.B	
3	OSSD 4.A	OSSD pair 4, OSSD A
4	OSSD 4.B	
5	n.c.	Not connected
6	n.c.	Not connected
7	n.c.	Not connected
8	n.c.	Not connected
9	Uni-I 11	Universal input 11, configurable
10	Uni-I 12	Universal input 12, configurable
11	Uni-I 13	Universal input 13, configurable
12	Uni-I 14	Universal input 14, configurable
13	Uni-I 15	Universal input 15, configurable
14	Uni-I 16	Universal input 16, configurable
15	Uni-O 03	Universal output 3
16	Uni-O 04	Universal output 4
17	0 V DC	Voltage for inputs and outputs (0 V DC) *

* If at least one connection of the female connector is used, this 0 V connection must be connected in the control cabinet to 0 V DC of the power supply unit using a low-impedance and star-point connection.

For details see operating instructions

Dynamic control input (XG2, XG3)

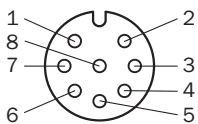





Pin	Designation	Description
1	n.c.	Not connected
2	Inc 0°	Incremental encoder signal (0°)
3	n.c.	Not connected
4	Inc 90°	Incremental encoder signal (90°)
5	n.c.	Not connected
6	n.c.	Not connected
7	0 V Inc	Supply voltage for incremental encoder (0 V DC)
8	24 V DC Inc	Supply voltage for incremental encoder (+24 V DC)

Pin	Designation	Description
For details see operating instructions		

Recommended accessories

Other models and accessories → www.sick.com/Safe_EFI-pro_System

Brief description	Type	Part no.
Mounting brackets and plates		
 <p>1 piece, mounting bracket with protection of optics hood, Stainless steel V2A (1.4301), powder-coated IGP-DURA face 5803A</p>	1b mounting kit	2074242
 <p>1 piece, mounting bracket, heavy-duty version, with protection cover, for floor mounting, height adjustment possible from 90 ... 310 mm, scanner tilt angle: ± 5°. Additional mounting brackets are not required. ⚙️, steel, painted (RAL 1021)</p>	Heavy-duty mounting kit for floor mounting	2102289
 <p>1 piece, mounting bracket 150 mm for floor mounting of microScan3, stainless steel, Bracket and 4 x M5 screws for attaching the microScan3</p>	Mounting bracket 150 mm for floor mounting of microScan3	2112950
 <p>1 piece, mounting bracket 300 mm for floor mounting of microScan3, stainless steel, Bracket and 4 x M5 screws for attaching the microScan3</p>	Mounting bracket 300 mm for floor mounting of microScan3	2112951
 <p>1 piece, mounting bracket, Stainless steel V2A (1.4301), powder-coated IGP-DURA face 5803A</p>	Mounting kit 1a	2073851
 <p>1 piece, alignment bracket, alignment with cross-wise axis and depth axis possible, distance between mounting surface and device: 22.3 mm, only in conjunction with mounting kit 1a (2073851) or 1b (2074242), Stainless steel V2A (1.4301), powder-coated IGP-DURA face 5803A</p>	Mounting kit 2a	2073852
 <p>1 piece, Alignment bracket, alignment with cross-wise axis and depth axis possible, distance between mounting surface and device: 52.3 mm, only in conjunction with mounting kit 1a (2073851) or 1b (2074242), Stainless steel V2A (1.4301), powder-coated IGP-DURA face 5803A</p>	Mounting kit 2b	2074184
Plug connectors and cables		
 <ul style="list-style-type: none"> • Connection type head A: Male connector, M12, 4-pin, angled, D-coded • Connection type head B: Male connector, RJ45, 8-pin, straight • Signal type: Ethernet • Cable: 20 m, 4-wire, CAT5, CAT5e, PUR, halogen-free • Description: Ethernet, shielded, Head A: male connector, M12, 4-pin, angled, D coded Head B: male connector, RJ45, 8-pin, straight Cable: PUR, halogen-free, shielded, 2 x 2 x 0.14 mm², Ø 6.4 mm 	SSL-2J04-H20ME	6063701
 <ul style="list-style-type: none"> • Connection type head A: Male connector, M12, 4-pin, straight, D-coded • Connection type head B: Male connector, RJ45, 4-pin, straight • Signal type: Ethernet, PROFINET • Cable: 5 m, 4-wire, PUR, halogen-free • Description: Ethernet, PROFINET, shielded • Application: Drag chain operation, Zones with oils and lubricants 	YM2D24-050PN1MRJA4	2106184
 <ul style="list-style-type: none"> • Connection type head A: Male connector, M12, 4-pin, angled, D-coded • Connection type head B: Male connector, RJ45, 4-pin, straight • Signal type: Ethernet, PROFINET • Cable: 5 m, 4-wire, PUR, halogen-free • Description: Ethernet, PROFINET, shielded • Application: Drag chain operation, Zones with oils and lubricants 	YN2D24-050PN1MRJA4	2106163

	Brief description	Type	Part no.
Others			
	<ul style="list-style-type: none"> • Connection type head A: Female connector, M12, 4-pin, straight • Connection type head B: Flying leads • Signal type: Sensor/actuator cable • Cable: 5 m, 4-wire, PUR, halogen-free • Description: Sensor/actuator cable, unshielded, Head A: female connector, M12, 4-pin, straight Head B: cable Cable: for voltage supply, suitable for drag chains, PUR, halogen-free, unshielded, 4 x 0.75 mm², Ø 5.9 mm • Connection systems: Flying leads • Application: Zones with oils and lubricants, Drag chain operation 	DOL-1204G05MC75KM0	2079291
	<ul style="list-style-type: none"> • Connection type head A: Female connector, M12, 4-pin, angled • Connection type head B: Flying leads • Signal type: Sensor/actuator cable • Cable: 5 m, 4-wire, PUR, halogen-free • Description: Sensor/actuator cable, unshielded, Head A: female connector, M12, 4-pin, angled Head B: cable Cable: for voltage supply, suitable for drag chains, PUR, halogen-free, unshielded, 4 x 0.75 mm², Ø 5.9 mm • Connection systems: Flying leads • Application: Zones with oils and lubricants, Drag chain operation 	DOL-1204W05MC75KM0	2079294
	<ul style="list-style-type: none"> • Connection type head A: Female connector, M12, 8-pin, straight, A-coded • Connection type head B: Male connector, M12, 8-pin, straight, A-coded • Signal type: Sensor/actuator cable • Cable: 2 m, 8-wire, PUR, halogen-free • Description: Sensor/actuator cable, shielded • Application: Zones with oils and lubricants, Drag chain operation 	YF2A28-020UA6M2A28	2096105
	<ul style="list-style-type: none"> • Brief description: The software visualizes diagnostic and device information from safety laser scanners in real time, helping to identify error causes faster and reduce maintenance time. • Supported products: All microScan3 variants (except for microScan3 Core I/O variants), outdoorScan3 Pro - EtherNet/IP • Version: 1.0 • Note: With purchase, you accept the product description available under Downloads > Documentation in connection with the General Terms and Conditions for the Supply of Software Products (AVB Software SICK)., With purchase, you accept the product description available under Downloads > Documentation in connection with the General Terms and Conditions for the Supply of Software Products (AVB Software SICK). 	SOW/VTL-LI007PCWIO	1116788
	YM2A1D-100UV1XLEAX	YM2A1D-100UV1XLEAX	2118016
	YN2A1D-100UV1XLEAX	YN2A1D-100UV1XLEAX	2118011

SICK AT A GLANCE

SICK is one of the leading manufacturers of intelligent sensors and sensor solutions for industrial applications. A unique range of products and services creates the perfect basis for controlling processes securely and efficiently, protecting individuals from accidents and preventing damage to the environment.

We have extensive experience in a wide range of industries and understand their processes and requirements. With intelligent sensors, we can deliver exactly what our customers need. In application centers in Europe, Asia and North America, system solutions are tested and optimized in accordance with customer specifications. All this makes us a reliable supplier and development partner.

Comprehensive services complete our offering: SICK LifeTime Services provide support throughout the machine life cycle and ensure safety and productivity.

For us, that is “Sensor Intelligence.”

WORLDWIDE PRESENCE:

Contacts and other locations –www.sick.com