

XC40S-0903A0A00AA0

C4000 Select

SAFETY LIGHT CURTAINS

SICK
Sensor Intelligence.

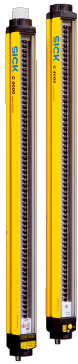

Illustration may differ



Ordering information

Resolution	Scanning range	Protective field height	System part	Type	Part no.
30 mm	21 m	900 mm	Sender	XC40S-0903A0A00AA0	1204071

Other models and accessories → www.sick.com/C4000_Select

Detailed technical data

Features

Application	Normal industrial environment
System part	Sender
Resolution	30 mm
Scanning range	21 m
Protective field height	900 mm
Synchronization	Optical synchronisation
Integrated laser alignment aid	✓

Safety-related parameters

Type	Type 4 (IEC 61496-1)
Safety integrity level	SIL 3 (IEC 61508)
Category	Category 4 (EN ISO 13849)
Performance level	PL e (EN ISO 13849)
PFH_D (mean probability of a dangerous failure per hour)	3.2×10^{-8} (EN ISO 13849)
T_M (mission time)	20 years (EN ISO 13849)
Safe state in the event of a fault	At least one OSSD is in the OFF state.

Functions

	Functions	Delivery status
Protective operation	✓	
Beam coding	✓	Uncoded
Configurable scanning range	✓	
Floating blanking	✓	

Interfaces

System connection	Male connector M12, 5-pin
--------------------------	---------------------------

¹⁾ Depending on load, power supply and wire cross-section. The technical specifications must be observed.

Permitted cable length	≤ 30 m ¹⁾
Configuration method	DIP switch
Display elements	7-segment display

¹⁾ Depending on load, power supply and wire cross-section. The technical specifications must be observed.

Electrical data

Protection class	III (IEC 61140)
Supply voltage V_S	24 V DC (19.2 V ... 28.8 V) ¹⁾
Residual ripple	≤ 10 % ²⁾

¹⁾ The external voltage supply must be capable of buffering brief mains voltage failures of 20 ms as specified in EN 60204-1. Suitable power supplies are available as accessories from SICK.

²⁾ Within the limits of V_S.

Mechanical data

Dimensions	See dimensional drawing
Housing material	Aluminum extruded profile

Ambient data

Enclosure rating	IP65 (EN 60529)
Ambient operating temperature	0 °C ... +55 °C
Storage temperature	-25 °C ... +70 °C
Air humidity	15 % ... 95 %, Non-condensing
Vibration resistance	5 g, 10 Hz ... 55 Hz (EN 60068-2-6)
Shock resistance	10 g, 16 ms (EN 60068-2-27)

Other information

Wave length	850 nm
Integrated laser alignment aid	✓
Light source	LED
Laser class	1 (IEC 60825-1), eye-safe
Type of light	Visible red light

Classifications

eCl@ss 5.0	27272704
eCl@ss 5.1.4	27272704
eCl@ss 6.0	27272704
eCl@ss 6.2	27272704
eCl@ss 7.0	27272704
eCl@ss 8.0	27272704
eCl@ss 8.1	27272704
eCl@ss 9.0	27272704
eCl@ss 10.0	27272704
eCl@ss 11.0	27272704
eCl@ss 12.0	27272704
ETIM 5.0	EC002549

ETIM 6.0	EC002549
ETIM 7.0	EC002549
ETIM 8.0	EC002549
UNSPSC 16.0901	46171620

Dimensional drawing (Dimensions in mm (inch))

Sender

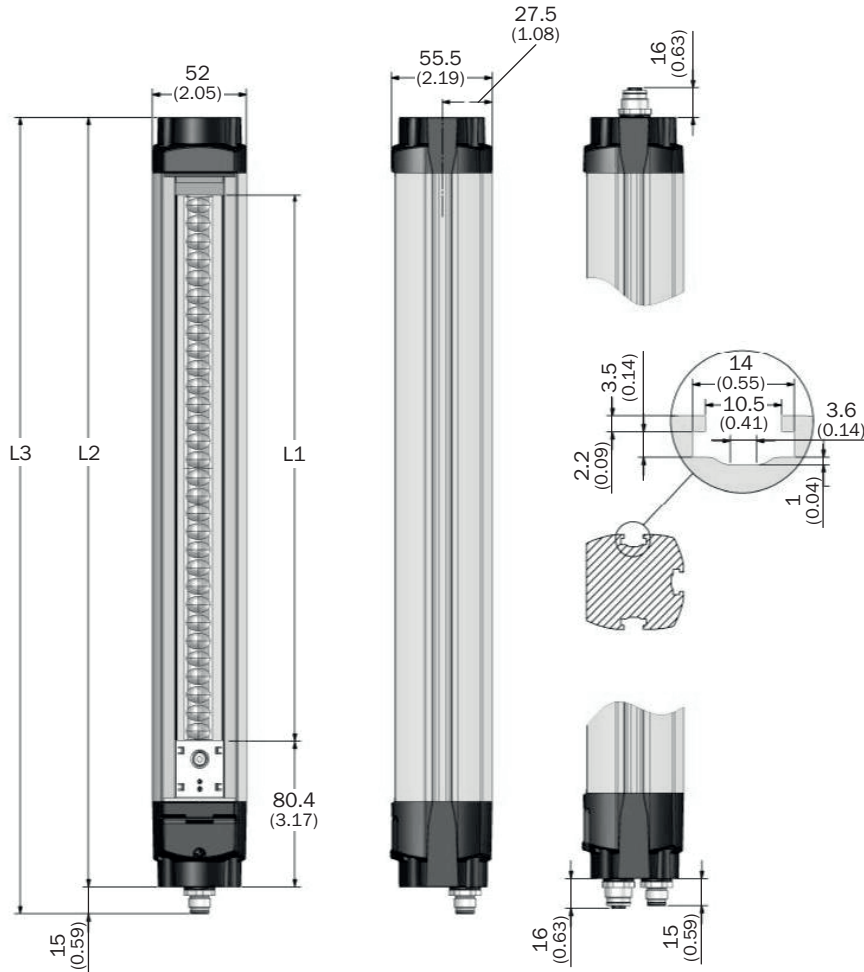





Protective field height S	L1	L2	L3
300 (11.81)	302 (11.89)	425 (16.73)	440 (17.32)
450 (17.72)	452 (17.80)	575 (22.64)	590 (23.23)
600 (23.62)	602 (23.70)	725 (28.54)	740 (29.13)
750 (29.53)	752 (29.61)	875 (34.45)	890 (35.04)
900 (35.43)	902 (35.51)	1,025 (40.35)	1,040 (40.94)
1,050 (41.34)	1,052 (41.42)	1,175 (46.26)	1,190 (46.85)
1,200 (47.24)	1,202 (47.32)	1,325 (52.17)	1,340 (52.76)
1,350 (53.15)	1,352 (53.23)	1,475 (58.07)	1,490 (58.66)
1,500 (59.06)	1,502 (59.13)	1,625 (63.98)	1,640 (64.57)

Protective field height S	L1	L2	L3
1,650 (64.96)	1,652 (65.04)	1,775 (69.88)	1,790 (70.47)
1,800 (70.87)	1,802 (70.94)	1,925 (75.79)	1,940 (76.38)

Recommended accessories

Other models and accessories → www.sick.com/C4000_Select

	Brief description	Type	Part no.
Alignment aids			
	Laser alignment aid for various sensors, laser class 2 (IEC 60825). Do not look into the beam!, 19 mm x 67.3 mm x 66.9 mm	AR60	1015741
Optics cloths			
	Cloth for cleaning optical surfaces	Lens cloth	4003353
Mounting brackets and plates			
	4 pieces, Mounting kit 1, mounting bracket, rigid, L-shaped, including fixing screws and washers	BEF-3WNGBAST4	7021352
Terminal and alignment brackets			
	4 pieces, Mounting kit 6, side bracket, rotatable, zinc diecast	BEF-1SHABAZN4	2019506
	4 pieces, Mounting kit 12, rotatable, swivel mount	BEF-2SMGEAKU4	2030510

SICK AT A GLANCE

SICK is one of the leading manufacturers of intelligent sensors and sensor solutions for industrial applications. A unique range of products and services creates the perfect basis for controlling processes securely and efficiently, protecting individuals from accidents and preventing damage to the environment.

We have extensive experience in a wide range of industries and understand their processes and requirements. With intelligent sensors, we can deliver exactly what our customers need. In application centers in Europe, Asia and North America, system solutions are tested and optimized in accordance with customer specifications. All this makes us a reliable supplier and development partner.

Comprehensive services complete our offering: SICK LifeTime Services provide support throughout the machine life cycle and ensure safety and productivity.

For us, that is “Sensor Intelligence.”

WORLDWIDE PRESENCE:

Contacts and other locations –www.sick.com