



LM36-750

LM/LT

FIBERS

SICK
Sensor Intelligence.



Illustration may differ

Ordering information

Type	Part no.
LM36-750	2015234

Other models and accessories → www.sick.com/LM_LT

Detailed technical data

Features

Device type	Fiber-optic cables
Functional principle	Proximity system
Compatible fiber-optic amplifiers	WLL12
Fiber length	750 mm
Fiber material	Glass fiber
Jacket material	Chrome-plated helical metal spring with PVC sheathing

Mechanics/electronics

Weight	54 g
Bend radius, optical fiber cable	20 mm
Ambient operating temperature	-10 °C ... +60 °C

Classifications

ECLASS 5.0	27270905
ECLASS 5.1.4	27270905
ECLASS 6.0	27270905
ECLASS 6.2	27270905
ECLASS 7.0	27270905
ECLASS 8.0	27270905
ECLASS 8.1	27270905
ECLASS 9.0	27270905
ECLASS 10.0	27270905
ECLASS 11.0	27270905
ECLASS 12.0	27270905
ETIM 5.0	EC002651
ETIM 6.0	EC002651
ETIM 7.0	EC002651
ETIM 8.0	EC002651
UNSPSC 16.0901	39121528

Dimensional drawing (Dimensions in mm (inch))

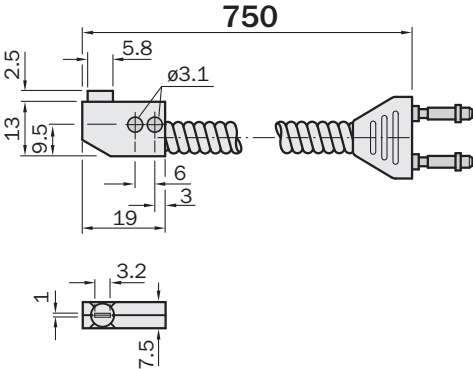

SICK AT A GLANCE

SICK is one of the leading manufacturers of intelligent sensors and sensor solutions for industrial applications. A unique range of products and services creates the perfect basis for controlling processes securely and efficiently, protecting individuals from accidents and preventing damage to the environment.

We have extensive experience in a wide range of industries and understand their processes and requirements. With intelligent sensors, we can deliver exactly what our customers need. In application centers in Europe, Asia and North America, system solutions are tested and optimized in accordance with customer specifications. All this makes us a reliable supplier and development partner.

Comprehensive services complete our offering: SICK LifeTime Services provide support throughout the machine life cycle and ensure safety and productivity.

For us, that is “Sensor Intelligence.”

WORLDWIDE PRESENCE:

Contacts and other locations –www.sick.com