



MLSE-0500A2NP0

MLS

MAGNETIC SENSORS

SICK
Sensor Intelligence.



Ordering information

Type	Part no.
MLSE-0500A2NP0	1090690

Other models and accessories → www.sick.com/MLS



Detailed technical data

Features

Detection range typ.	500 mm
Operating height	10 mm ... 70 mm
Electrical wiring	DC 4-wire
Enclosure rating	IP65, IP67, IP68 ¹⁾

¹⁾ According to EN 60529.

Mechanics/electronics

Supply voltage	9 V DC ... 30 V DC
Terminal resistor	No internal terminator
Protection class	III
Power consumption	600 mW
Resolution, typ.	1 mm
Repeat accuracy, typ.	1 mm
Update rate	100 Hz
Teach-in	✓
Reverse polarity protection	✓
Short-circuit protection	✓
Ambient operating temperature	-20 °C ... +70 °C
Shock and vibration resistance	30 g, 11 ms/10 Hz ... 55 Hz, 1 mm
EMC	EN 61000-6-2, EN 61000-6-4
Connection type	Cable with M8 male connector, 4-pin, 0.3 m ¹⁾
Connection type Detail	
Conductor cross section	0.08 mm ²
Material	
Housing	Metal, Aluminum, plastic
Cable	PUR

¹⁾ Do not bend below 0 °C.

UL File No.	NRKH.E181493 & NRKH7.E181493
--------------------	------------------------------

¹⁾ Do not bend below 0 °C.

Safety-related parameters

MTTF_D	103 years
DC_{avg}	0 %
T_M (mission time)	20 years

Communication interface

Communication interface	CANopen
--------------------------------	---------

Diagnosis

Orientation	
Number of axis	3
Roll Euler angle measuring range	± 180°
Pitch Euler angle measuring range	± 90°
Yaw Euler angle measuring range	± 180°
Resolution	0.02°
Roll repeatability	± 1°
Pitch repeatability	± 1°
Yaw repeatability	± 1° ¹⁾
Maximum rotation rate	2,000 °/s
Quaternion w measuring range	0 ... + 1
Quaternion x measuring range	-1 ... 1
Quaternion y measuring range	-1 ... 1
Quaternion z measuring range	-1 ... 1
Update rate	100 Hz
Limit frequency	100 Hz
Initialization time	640 ms
Sampling rate	200 Hz ²⁾
Acceleration measuring range	± 16 g ²⁾
Rotation rate measuring range	± 2,000 °/s ²⁾

¹⁾ Not long-term stable.

²⁾ Raw data.

Classifications

ECLASS 5.0	27270104
ECLASS 5.1.4	27270104
ECLASS 6.0	27270104
ECLASS 6.2	27270104
ECLASS 7.0	27270104
ECLASS 8.0	27270104
ECLASS 8.1	27270104
ECLASS 9.0	27270104

ECLASS 10.0	27270104
ECLASS 11.0	27270104
ECLASS 12.0	27274301
ETIM 5.0	EC002544
ETIM 6.0	EC002544
ETIM 7.0	EC002544
ETIM 8.0	EC002544
UNSPSC 16.0901	39122230

Connection diagram

Cd-396

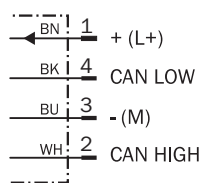

Dimensional drawing (Dimensions in mm (inch))

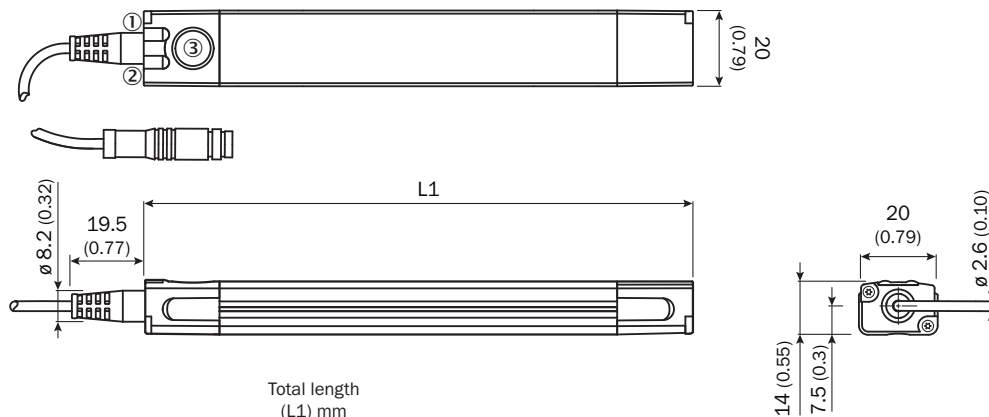

Total length
(L1) mm

MLSE-0200	217
MLSE-0300	325
MLSE-0400	397
MLSE-0500	505
MLSE-0600	613

- ① Function signal indicator 1
- ② Function signal indicator 2
- ③ Teach-Pad

Recommended accessories

Other models and accessories → www.sick.com/MLS

	Brief description	Type	Part no.
Bus adapter			
	CAN-USB Adapter to connect MLS with a PC	AKA-NXL1BXB12KX	6067651
Magnets			
	Magnetic tape, North is top side, adhesive, width 25 mm, length 50 m	MAGNETIC TAPE	5337613
	Magnetic tape, South is top side, adhesive, width 25 mm, length 50 m	MAGNETIC TAPE	5337614
	Magnetic tape, north pole on top, self-adhesive, width = 25mm, external length = 524 mm, internal length = 511 mm, radius = 1000 mm, 30° section	Magnetic tape, curved	5344198
	Positioning device for magnetic markers (5337613, 5337614) for MLS	TEMPLATE	4097520
Mounting brackets and plates			
	Bracket for low mounting, Stainless steel V2A (bracket/mounting screw), Brass (fixing screw)	BEF-WNLO1MPA	2065973
	Bracket for lateral mounting, Stainless steel V2A (bracket/mounting screw), Brass (fixing screw)	BEF-WNZ01MPA	2065577
	<ul style="list-style-type: none"> Connection type head A: Female connector, M8, 4-pin, straight, A-coded Connection type head B: Flying leads Signal type: Sensor/actuator cable Cable: 2 m, 4-wire, PUR, halogen-free Description: Sensor/actuator cable, unshielded Application: Zones with oils and lubricants, Drag chain operation, Robot 	YF8U14-020UA3XLEAX	2094791
	<ul style="list-style-type: none"> Connection type head A: Female connector, M8, 4-pin, straight, A-coded Connection type head B: Flying leads Signal type: Sensor/actuator cable Cable: 5 m, 4-wire, PUR, halogen-free Description: Sensor/actuator cable, unshielded Application: Zones with oils and lubricants, Drag chain operation, Robot 	YF8U14-050UA3XLEAX	2094792
	<ul style="list-style-type: none"> Connection type head A: Female connector, M8, 4-pin, angled, A-coded Connection type head B: Flying leads Signal type: Sensor/actuator cable Cable: 2 m, 4-wire, PUR, halogen-free Description: Sensor/actuator cable, unshielded Application: Zones with oils and lubricants, Drag chain operation, Robot 	YG8U14-020UA3XLEAX	2095589
	<ul style="list-style-type: none"> Connection type head A: Female connector, M8, 4-pin, angled, A-coded Connection type head B: Flying leads Signal type: Sensor/actuator cable Cable: 5 m, 4-wire, PUR, halogen-free Description: Sensor/actuator cable, unshielded Application: Zones with oils and lubricants, Drag chain operation, Robot 	YG8U14-050UA3XLEAX	2095590
	<ul style="list-style-type: none"> Description: Y-cable to connect MLS to a CAN-USB Adapter and a power supply (Input: 100-240V, 1.0A max., 50-60Hz; Output: +24V DC; Connector: 2.1x5.5x11-S) 	YF8U14-011VA3FYDN2	2098412

SICK AT A GLANCE

SICK is one of the leading manufacturers of intelligent sensors and sensor solutions for industrial applications. A unique range of products and services creates the perfect basis for controlling processes securely and efficiently, protecting individuals from accidents and preventing damage to the environment.

We have extensive experience in a wide range of industries and understand their processes and requirements. With intelligent sensors, we can deliver exactly what our customers need. In application centers in Europe, Asia and North America, system solutions are tested and optimized in accordance with customer specifications. All this makes us a reliable supplier and development partner.

Comprehensive services complete our offering: SICK LifeTime Services provide support throughout the machine life cycle and ensure safety and productivity.

For us, that is “Sensor Intelligence.”

WORLDWIDE PRESENCE:

Contacts and other locations –www.sick.com