



IPG2-2320A5P167

**SICK**  
Sensor Intelligence.



## Ordering information

Type	Part no.
IPG2-2320A5P167	2082189

Other models and accessories → [www.sick.com/](http://www.sick.com/)



## Detailed technical data

### Technical specifications

<b>Accessory group</b>	Device protection (mechanical)
<b>Accessory family</b>	Protective housings and protective pipes
<b>Suitable for</b>	Protective pipe for MLG-2, monitoring height 2,200 mm ... 2,245 mm
<b>Material</b>	PMMA (protective pipes), Aluminum (end caps, spacer), ABS-plastic (support holder), Polyamide (cable gland)
<b>Color</b>	Transparent
<b>Dimensions (W x H x L)</b>	50 mm x 50 mm x 2,320 mm <sup>1)</sup>
<b>Description</b>	Enclosure rating: IP 67; ambient temperature from ... to: -20 °C ... +55 °C

<sup>1)</sup> Visible protective pipe (PMMA).

### Classifications

<b>ECLASS 5.0</b>	27279202
<b>ECLASS 5.1.4</b>	27279202
<b>ECLASS 6.0</b>	27279202
<b>ECLASS 6.2</b>	27279202
<b>ECLASS 7.0</b>	27279202
<b>ECLASS 8.0</b>	27279202
<b>ECLASS 8.1</b>	27279202
<b>ECLASS 9.0</b>	27273701
<b>ECLASS 10.0</b>	27273701
<b>ECLASS 11.0</b>	27273701
<b>ECLASS 12.0</b>	27273701
<b>ETIM 5.0</b>	EC002615
<b>ETIM 6.0</b>	EC002615
<b>ETIM 7.0</b>	EC002615
<b>ETIM 8.0</b>	EC002615
<b>UNSPSC 16.0901</b>	32131023

Dimensional drawing (Dimensions in mm (inch))

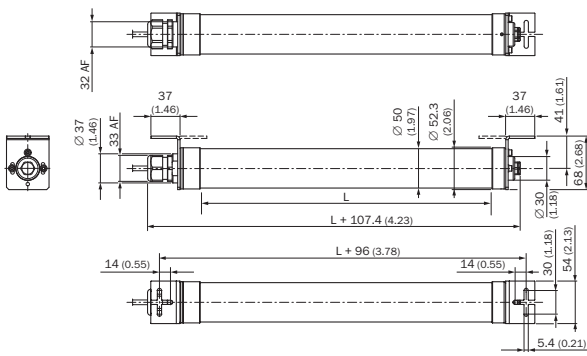

Monitoring height (L) mm	Protection pipe (L) mm	Monitoring height (L) mm	Protection pipe (L) mm	Monitoring height (L) mm	Protection pipe (L) mm
<b>100 ... 145</b>	220	<b>1,000 ... 1,045</b>	1,120	<b>1,900 ... 1,945</b>	2,020
<b>250 ... 295</b>	370	<b>1,150 ... 1,195</b>	1,270	<b>2,050 ... 2,095</b>	2,170
<b>400 ... 445</b>	520	<b>1,300 ... 1,345</b>	1,420	<b>2,200 ... 2,245</b>	2,320
<b>550 ... 595</b>	670	<b>1,450 ... 1,495</b>	1,570	<b>2,350 ... 2,395</b>	2,470
<b>700 ... 745</b>	820	<b>1,600 ... 1,645</b>	1,720	<b>2,500 ... 2,545</b>	2,620
<b>850 ... 895</b>	970	<b>1,750 ... 1,795</b>	1,870	<b>2,650 ... 2,695</b>	2,770
				<b>2,800 ... 2,845</b>	2,920

## SICK AT A GLANCE

SICK is one of the leading manufacturers of intelligent sensors and sensor solutions for industrial applications. A unique range of products and services creates the perfect basis for controlling processes securely and efficiently, protecting individuals from accidents and preventing damage to the environment.

We have extensive experience in a wide range of industries and understand their processes and requirements. With intelligent sensors, we can deliver exactly what our customers need. In application centers in Europe, Asia and North America, system solutions are tested and optimized in accordance with customer specifications. All this makes us a reliable supplier and development partner.

Comprehensive services complete our offering: SICK LifeTime Services provide support throughout the machine life cycle and ensure safety and productivity.

For us, that is “Sensor Intelligence.”

## WORLDWIDE PRESENCE:

Contacts and other locations –[www.sick.com](http://www.sick.com)