



S30A-6111DL

S3000 PROFINET IO Professional

SAFETY LASER SCANNERS

SICK
Sensor Intelligence.



Illustration may differ



Ordering information

Type	Part no.
S30A-6111DL	1052594

Usage

The system plug has to be ordered separately. For details, see "Accessories, plug connectors and cables".

Network cable and male connector cannot be purchased from SICK.

Other models and accessories → www.sick.com/S3000_PROFINET_IO_Professional

Detailed technical data

Features

Usage	S3000 PROFINET IO does not have any local inputs or outputs and is only operated in a network with corresponding controller.
Model	Sensor without system plug
Application	Indoor
Protective field range	5.5 m
Warning field range	49 m (20 m at 20 % reflectivity)
Distance measuring range	49 m
Number of simultaneously monitored protective fields	2
Type of field set	Dual field sets
Number of field sets	8
Number of fields	16
Number of monitoring cases	16
Scanning angle	190°
Resolution (can be configured)	30 mm, 40 mm, 50 mm, 70 mm, 150 mm
Angular resolution	0.5°, 0.25°, depending on range and resolution
Response time	60 ms ¹⁾
Protective field supplement	100 mm
Number of multiple samplings	2 ... 16, configurable
Delay of automatic reset	120 ms ... 4,920 ms, configurable

¹⁾ Depending on basic response time and multiple sampling.

Safety-related parameters

Type	Type 3 (IEC 61496)
Safety integrity level	SIL 2 (IEC 61508)
Category	Category 3 (EN ISO 13849)
Performance level	PL d (EN ISO 13849)
PFH_D (mean probability of a dangerous failure per hour)	8.0 x 10 ⁻⁸
T_M (mission time)	20 years (EN ISO 13849)
Safe state in the event of a fault	The safety-related data is logic 0.

Functions

Restart interlock	✓
Multiple sampling	✓
Monitoring case switching	✓
Simultaneous monitoring	✓
Static protective field switching	✓
Contour as a reference	✓
Integrated configuration memory	✓
Measured data output	Via RS-422

Interfaces

Connection type	
Bus connection	Optical fiber conductor (2 female connectors for SCRJ push-pull plug)
Supply connection	System plug with or without connecting cable
Configuration and diagnostics interface	RS-232
Transmission rate	9.6 kBaud, 19.2 kBaud, 38.4 kBaud
Fieldbus, industrial network	PROFINET PROFI-safe
Type of fieldbus integration	Integrated in the device
Device properties	PROFINET IO device with 2-port real-time switch according to PROFINET specification V2.2 PROFI-safe profile with 6-octet input and 6-octet output according to IEC 61784-3-3 V2.4 Cycle time 4, 8, 16, 32 ms, etc. GSDML according to GSDML specification V2.25
Switch properties	Filtering Data Base according to IEEE 802.1D 6 prioritization levels for IEEE 802.1Q – Network prioritization 64 KB SRAM memory for caching telegrams, managed in 768-byte segments Resource prioritization for network control and RTC2/3 frames Telegram extension based on "Cut-through" Port status (Disabled, Blocking, Forwarding) Support for non-real-time and real-time data transfer
Port properties	Auto-negotiation Auto-crossover (MDIX) Auto-polarity 100Base-FX
Conformance	Conformance Class B
Topology support	SNMP, MIB-2, LLDP according to IEEE 802.1AB MRP client support
Diagnostics	Application-related manufacturer-specific channel diagnostics and channel diagnostics for the PROFI-safe profile, individually switchable Report system errors Maintenance alerts for POF interfaces for signal quality Cable diagnostics

	Neighborhood alerts Support for port statistics I&M support from I&M0 to I&M4
Interfaces	TCP port 9000 and UDP port 30718 RS-232
Functions that are not supported	Multicast communication Supervisor AR MAC-pause mechanism in full duplex Back-pressure in half duplex Static learning Broadcast Storm Control

Electrical data

Protection class	III (VDE 0106, EN 60950)
Supply voltage V_s	24 V DC (16.8 V DC ... 28.8 V DC)
Power consumption	$\leq 0.8 \text{ A}^{1)}$

¹⁾ At 24 V DC without output load.

Mechanical data

Dimensions (W x H x D)	155 mm x 185 mm x 160 mm
Weight	3.3 kg
Housing material	Aluminum die cast
Housing color	RAL 1021 (yellow)
Front screen material	Polycarbonate
Front screen surface finish	Outside with scratch-resistant coating

Ambient data

Enclosure rating	IP65 (EN 60529)
Ambient operating temperature	-10 °C ... +50 °C
Storage temperature	-25 °C ... +50 °C
Vibration resistance	IEC 60068-2-6, IEC 60068-2-64, IEC 60721-3-5, IEC TR 60721-4-5, IEC 61496-3
Class	5M1 (IEC 60721-3-5)
Shock resistance	IEC 60068-2-27, IEC 60721-3-5, IEC TR 60721-4-5, IEC 61496-3
Class	5M1 (IEC 60721-3-5)
Continuous shock	50 m/s ² , 11 ms 100 m/s ² , 16 ms

Other information

Type of light	Pulsed laser diode
Wave length	905 nm
Detectable remission factor	1.8 % ... > 1,000 %, reflectors
Laser class	1 (21 CFR 1040.10 and 1040.11, IEC 60825-1)

Classifications

ECLASS 5.0	27272705
ECLASS 5.1.4	27272705
ECLASS 6.0	27272705
ECLASS 6.2	27272705
ECLASS 7.0	27272705



ECLASS 8.0	27272705
ECLASS 8.1	27272705
ECLASS 9.0	27272705
ECLASS 10.0	27272705
ECLASS 11.0	27272705
ECLASS 12.0	27272705
ETIM 5.0	EC002550
ETIM 6.0	EC002550
ETIM 7.0	EC002550
ETIM 8.0	EC002550
UNSPSC 16.0901	39121528

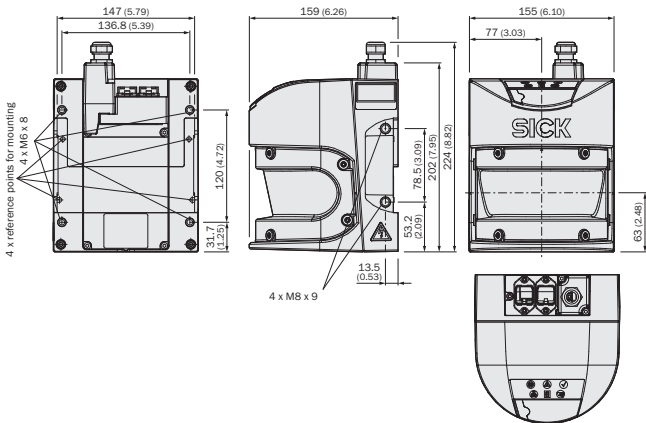





Dimensional drawing (Dimensions in mm (inch))



Recommended accessories

Other models and accessories → www.sick.com/S3000_PROFINET_IO_Professional

	Brief description	Type	Part no.
Mounting brackets and plates			
	1 piece, Visor for heavy duty mounting kit (2080350), steel, painted (RAL 1021)	Heavy duty sight	2083733
	1 piece, Mounting bracket, heavy-duty version, with protection cover, for floor mounting, adjustable longitudinal and lateral axes via alignment plate, height adjustment possible. Tilt angle ± 5°. Additional mounting brackets are not required., steel, painted (RAL 1021)	Heavy-duty mounting kit	2080350
	1 piece, mounting bracket for direct mounting, from the rear, on wall or machine, not adjustable, Aluminum	Mounting kit 1	2015623

	Brief description	Type	Part no.
	1 piece, mounting bracket for rear mounting on wall or machine, adjustable longitudinal and lateral axes, only in conjunction with mounting kit 1 (2015623), Aluminum	Mounting kit 2	2015624
	1 piece, mounting bracket for rear mounting on wall, floor, or machine, adjustable longitudinal and lateral axes, only in conjunction with mounting kit 1 (2015623) and 2 (2015624), Aluminum	Mounting kit 3	2015625
Others			
	<ul style="list-style-type: none"> • Connection type head A: Male connector, M8, 4-pin, straight • Connection type head B: Male connector, USB-A, straight • Cable: 10 m, 4-wire, PVC • Description: Unshielded, Configuration cable with integrated RS-232 transducer on USB for connecting a sensor configuration connection (M8, 4-pin) to the USB interface of a PC 	DSL-8U04G10M025KM1	6034575
	<ul style="list-style-type: none"> • Connection type head A: Male connector, M8, 4-pin, straight • Connection type head B: Male connector, USB-A, straight • Cable: 2 m, 4-wire, PVC • Description: Unshielded, Configuration cable with integrated RS-232 transducer on USB for connecting a sensor configuration connection (M8, 4-pin) to the USB interface of a PC 	DSL-8U04G02M025KM1	6034574
	<ul style="list-style-type: none"> • Connection type head A: System plug • Description: Without cable, Not for use of incremental encoders, integrated configuration storage, For S3000 PROFINET IO Advanced and Professional • Items supplied: With 1 x cable gland M16 	SX1A-A0000L	2047286
	<ul style="list-style-type: none"> • Connection type head A: System plug • Cable: 1 m, 2-wire, PVC • Description: Pre-assembled, Not for use of incremental encoders, integrated configuration storage, unshielded, For S3000 PROFINET IO Advanced and Professional • Connection systems: Flying leads • Items supplied: With 1 x cable gland M16 	SX1A-B0201L	2049575
	<ul style="list-style-type: none"> • Connection type head A: System plug • Cable: 1 m, 2-wire, PVC • Description: Pre-assembled with power y-junction, Not for use of incremental encoders, integrated configuration storage, unshielded, For S3000 PROFINET IO Advanced and Professional • Items supplied: With 1 x cable gland M16 	SX1A-B0201M	2049857

SICK AT A GLANCE

SICK is one of the leading manufacturers of intelligent sensors and sensor solutions for industrial applications. A unique range of products and services creates the perfect basis for controlling processes securely and efficiently, protecting individuals from accidents and preventing damage to the environment.

We have extensive experience in a wide range of industries and understand their processes and requirements. With intelligent sensors, we can deliver exactly what our customers need. In application centers in Europe, Asia and North America, system solutions are tested and optimized in accordance with customer specifications. All this makes us a reliable supplier and development partner.

Comprehensive services complete our offering: SICK LifeTime Services provide support throughout the machine life cycle and ensure safety and productivity.

For us, that is “Sensor Intelligence.”

WORLDWIDE PRESENCE:

Contacts and other locations –www.sick.com