



# LBV330-XXAGDTKMX0800

LBV300

LEVEL SENSORS

**SICK**  
Sensor Intelligence.



Illustration may differ



### Ordering information

| Type                 | Part no. |
|----------------------|----------|
| LBV330-XXAGDTKMX0800 | 6039127  |

Other models and accessories → [www.sick.com/LBV300](http://www.sick.com/LBV300)

### Detailed technical data

#### Features

|                              |                           |
|------------------------------|---------------------------|
| <b>Medium</b>                | Bulk solids               |
| <b>Measurement</b>           | Switch                    |
| <b>Probe length</b>          | 800 mm                    |
| <b>Process pressure</b>      | -1 bar ... 25 bar         |
| <b>Process temperature</b>   | -50 °C ... +150 °C        |
| <b>Fill material density</b> | ≥ 0.008 g/cm <sup>3</sup> |
| <b>Particle size</b>         | < 10 mm                   |

#### Performance

|                                   |   |
|-----------------------------------|---|
| <b>Accuracy of sensor element</b> | ± 10 mm                                       |
| <b>Reproducibility</b>            | ≤ 5 mm  |
| <b>Response time</b>              | 500 ms when covered / 1,000 ms when uncovered |
| <b>MTBF</b>                       | 4,61*10 <sup>6</sup> h                        |

#### Electronics

|                               |   |
|-------------------------------|---|
| <b>Residual ripple</b>        | ≤ 5 V <sub>pp</sub>                                       |
| <b>Initialization time</b>    | < 2 s   |
| <b>VDE protection class 2</b> | ✓   |
| <b>Connection type</b>        | M20 x 1.5   |
| <b>Output signal</b>          | 1 x PNP/NPN   |
| <b>Supply voltage</b>         | Volt-free transistor output PNP/ NPN: 10 V DC ... 55 V DC |
| <b>Hysteresis</b>             | 10 mm   |
| <b>Output current</b>         | < 300 mA  |
| <b>Inductive load</b>         | ≤ 1 H   |
| <b>Capacitive load</b>        | 100 nF  |
| <b>Enclosure rating</b>       | IP66 / IP67   |

#### Mechanics

|                           |              |
|---------------------------|--------------|
| <b>Process connection</b> | G 1½ A PN 25 |
|---------------------------|--------------|

|                         |                        |
|-------------------------|------------------------|
| <b>Housing material</b> | Plastic                |
| <b>Sensor material</b>  | Stainless steel 1.4404 |

## Ambient data

|                                      |                   |
|--------------------------------------|-------------------|
| <b>Ambient operating temperature</b> | -40 °C ... +80 °C |
| <b>Ambient temperature, storage</b>  | -40 °C ... +80 °C |

## Classifications

|                       |          |
|-----------------------|----------|
| <b>ECLASS 5.0</b>     | 27273202 |
| <b>ECLASS 5.1.4</b>   | 27273202 |
| <b>ECLASS 6.0</b>     | 27273202 |
| <b>ECLASS 6.2</b>     | 27273202 |
| <b>ECLASS 7.0</b>     | 27273202 |
| <b>ECLASS 8.0</b>     | 27273202 |
| <b>ECLASS 8.1</b>     | 27273202 |
| <b>ECLASS 9.0</b>     | 27273202 |
| <b>ECLASS 10.0</b>    | 27273202 |
| <b>ECLASS 11.0</b>    | 27273202 |
| <b>ECLASS 12.0</b>    | 27273106 |
| <b>ETIM 5.0</b>       | EC002654 |
| <b>ETIM 6.0</b>       | EC002654 |
| <b>ETIM 7.0</b>       | EC002654 |
| <b>ETIM 8.0</b>       | EC002654 |
| <b>UNSPSC 16.0901</b> | 41111938 |

## Type code

## LBV330 type code

**Certification**

|    |   |
|----|---|
| XX | without   |
| CX | ATEX II 1G, ½ G, 2G Ex ia IIC T6                      |
| CK | ATEX II 1G, ½ G, 2G Ex ia IIC T6+ATEX II 1/2 D IP6X T |
| LX | ATEX II 1G, ½ G, 2G Ex d IIC T6                       |
| LK | ATEX II ½ G, 2G Ex d IIC T6+ATEX II 1/2 D, 2D IP6X    |
| GX | ATEX II ½ D IP6X T                                    |

**Execution / Process temperature**

|   |   |
|---|---|
| A | Standard / -50 °C ... +150 °C                     |
| B | With spacer / -50 °C ... +250 °C                  |
| C | Detection of solids in water / -50 °C ... +150 °C |

**Process connection / Material**

|                  |  |
|------------------|--|
| GD               | Thread G 1 ½ A, PN 25 / 316L                   |
| ND               | Thread 1 ½" NPT, PN 25 / 316L                  |
| EF               | Flange DN 50, PN 40, form C, DIN 2501 / 316L   |
| No<br>er-<br>ror | Flange DN 80, PN 40, form C, DIN 2501 / 316L   |
| ZF               | Flange DN 100, PN 6, form C, DIN 2501 / 316L   |
| MF               | Flange DN 100 PN 16 form C, DIN2501 / 316L     |
| OF               | Flange DN 100, PN 40, form C, DIN 2501 / 316L  |
| QF               | Flange DN 150, PN 16, form C, DIN 2501 / 316L  |
| 2F               | Flange DN 200, PN 10, form C, DIN 2501 / 316L  |
| EB               | Flange DN 50, PN 40, EN 1092-1, form B1 / 316L |
| HA               | Flange 2", 150 lb RF, ANSI B16.5 / 316L        |
| HE               | Flange 2", 150 lb FF, ANSI B16.5 / 316L        |



LBV330 threaded version G 1½ A (DIN ISO 228/1)

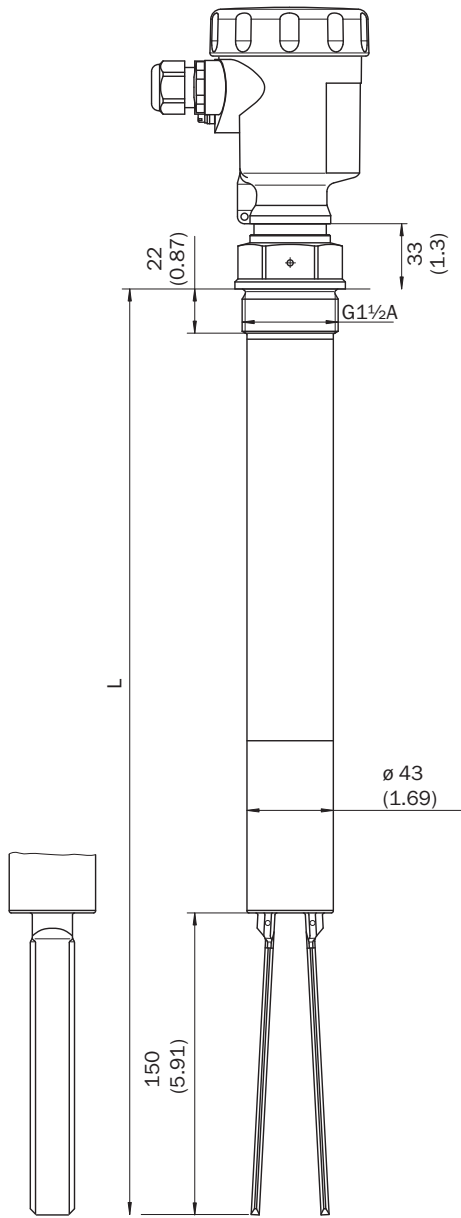

### Connection diagram

PNP action

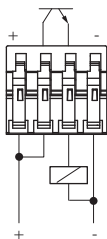

NPN action

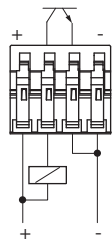

Transistor connection diagram

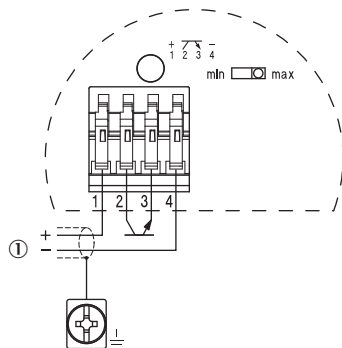

### Instruction for installation

Horizontal mounting

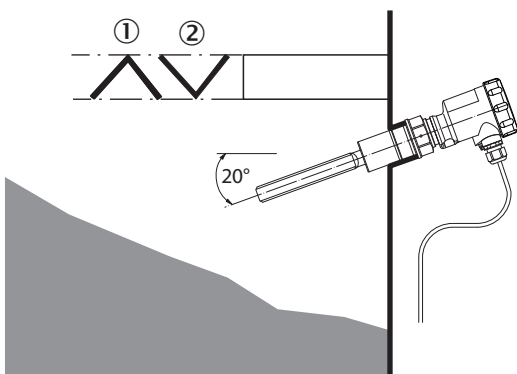

- ① Protective sheet
- ② Concave protective sheet for abrasive solids

Flow orientation of the tuning fork

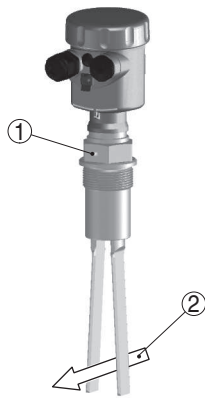

- ① Marking with screwed version
- ② Direction of flow

### Recommended accessories

Other models and accessories → [www.sick.com/LBV300](http://www.sick.com/LBV300)

|   | Brief description                         | Type                | Part no. |
|---|---|---------------------|----------|
| Electronic modules  |   |                     |          |
|  | Transistor (PNP/NPN): 10 V DC ... 55 V DC | ECD-RE-LB-VPNP-0001 | 6038667  |
| Mounting brackets and plates  |   |                     |          |
|   | BEF-MU-316G20-ALBV                        | BEF-MU-316G20-ALBV  | 5322462  |

## SICK AT A GLANCE

SICK is one of the leading manufacturers of intelligent sensors and sensor solutions for industrial applications. A unique range of products and services creates the perfect basis for controlling processes securely and efficiently, protecting individuals from accidents and preventing damage to the environment.

We have extensive experience in a wide range of industries and understand their processes and requirements. With intelligent sensors, we can deliver exactly what our customers need. In application centers in Europe, Asia and North America, system solutions are tested and optimized in accordance with customer specifications. All this makes us a reliable supplier and development partner.

Comprehensive services complete our offering: SICK LifeTime Services provide support throughout the machine life cycle and ensure safety and productivity.

For us, that is “Sensor Intelligence.”

## WORLDWIDE PRESENCE:

Contacts and other locations –[www.sick.com](http://www.sick.com)