



# WL2000-M4320

W2000

COMPACT PHOTOELECTRIC SENSORS

**SICK**  
Sensor Intelligence.



Illustration may differ



## Ordering information

Type	Part no.
WL2000-M4320	7023409

Other models and accessories → [www.sick.com/W2000](http://www.sick.com/W2000)

## Detailed technical data

### Features

<b>Functional principle</b>	Photoelectric retro-reflective sensor
<b>Dimensions (W x H x D)</b>	45 mm x 73.7 mm x 48.6 mm
<b>Housing design (light emission)</b>	Rectangular
<b>Sensing range max.</b>	0 m ... 15 m <sup>1)</sup>
<b>Sensing range</b>	0 m ... 15 m <sup>1)</sup>
<b>Focus</b>	Approx. 1.3°
<b>Type of light</b>	Visible red light
<b>Light source</b>	LED <sup>2)</sup>
<b>Light spot size (distance)</b>	Ø 320 mm (14 m)
<b>Angle of dispersion</b>	Approx. 1.3°
<b>Wave length</b>	660 nm
<b>Adjustment</b>	Potentiometer

<sup>1)</sup> Reflector PL80A.

<sup>2)</sup> Average service life: 100,000 h at T<sub>U</sub> = +25 °C.

### Mechanics/electronics

<b>Supply voltage</b>	90 V AC ... 240 V AC <sup>1)</sup>
<b>Power consumption</b>	≤ 6 W <sup>2)</sup>
<b>Switching output</b>	FET
<b>Switching mode</b>	Light/dark switching
<b>Switching mode selector</b>	Selectable via light/dark selector
<b>Switching current (switching voltage)</b>	150 mA (240 V)
<b>Response time</b>	≤ 2 ms <sup>3)</sup>

<sup>1)</sup> Limit values.

<sup>2)</sup> Without load.

<sup>3)</sup> Signal transit time with resistive load.

<sup>4)</sup> With light/dark ratio 1:1.

<sup>5)</sup> Adjustable via Off delay selector switch.

<sup>6)</sup> Adjustable via On delay selector switch.

<sup>7)</sup> Reference voltage: 50 V DC.

<b>Switching frequency</b>	250 Hz <sup>4)</sup>
<b>Time functions</b>	Off delay <sup>5)</sup> On delay <sup>6)</sup>
<b>Delay time</b>	≤ 0 s ≤ 1 s ≤ 5 s ≤ 10 s ≤ 14 s
<b>Connection type</b>	Mini connector, 4-pin
<b>Protection class</b>	II <sup>7)</sup>
<b>Weight</b>	150 g
<b>Polarisation filter</b>	✓
<b>Housing material</b>	Plastic, Glassfibre reinforced plastic
<b>Enclosure rating</b>	IP67
<b>Ambient operating temperature</b>	-25 °C ... +40 °C
<b>Ambient temperature, storage</b>	-40 °C ... +70 °C
<b>UL File No.</b>	242366 & cUL No. NRKH7.E147756

- 1) Limit values.
- 2) Without load.
- 3) Signal transit time with resistive load.
- 4) With light/dark ratio 1:1.
- 5) Adjustable via Off delay selector switch.
- 6) Adjustable via On delay selector switch.
- 7) Reference voltage: 50 V DC.

## Classifications

<b>eCl@ss 5.0</b>	27270902
<b>eCl@ss 5.1.4</b>	27270902
<b>eCl@ss 6.0</b>	27270902
<b>eCl@ss 6.2</b>	27270902
<b>eCl@ss 7.0</b>	27270902
<b>eCl@ss 8.0</b>	27270902
<b>eCl@ss 8.1</b>	27270902
<b>eCl@ss 9.0</b>	27270902
<b>eCl@ss 10.0</b>	27270902
<b>eCl@ss 11.0</b>	27270902
<b>eCl@ss 12.0</b>	27270902
<b>ETIM 5.0</b>	EC002717
<b>ETIM 6.0</b>	EC002717
<b>ETIM 7.0</b>	EC002717
<b>ETIM 8.0</b>	EC002717
<b>UNSPSC 16.0901</b>	39121528

Connection type

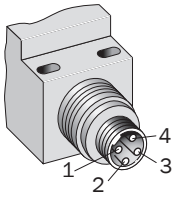

Connection diagram

Cd-125

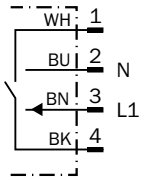

Characteristic curve

WL2000

Excess gain

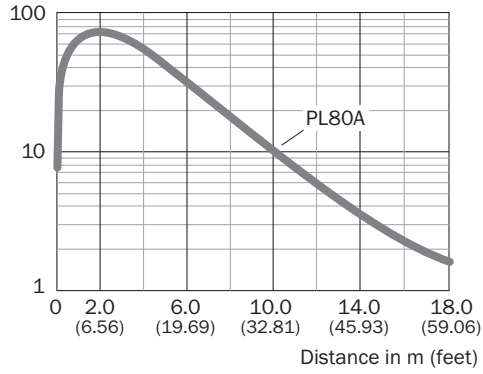

### Sensing range diagram

WL2000

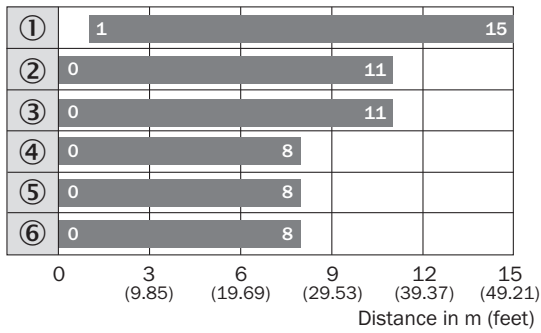

- Sensing range
- ① Reflector PL80A
- ② Reflector PL50A
- ③ Reflector PL40A
- ④ Reflector PL30A
- ⑤ Reflector PL20A
- ⑥ Reflective tape Diamond Grade

### Dimensional drawing (Dimensions in mm (inch))

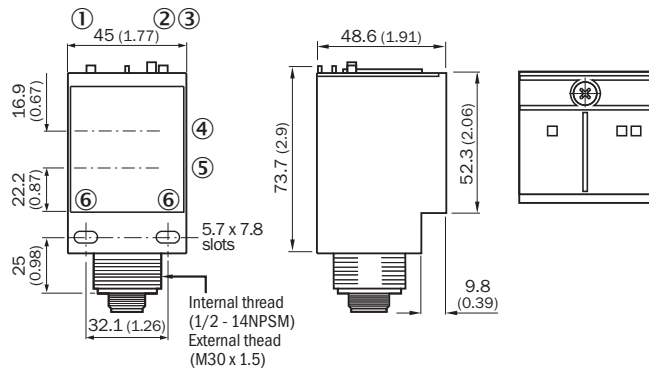

- ① LED indicator green: Supply voltage active
- ② Status indicator LED red: signal strength
- ③ Status indicator LED, yellow: Output active
- ④ Center of emitter optical axis
- ⑤ Center of receiver optical axis
- ⑥ Mounting hole  $\varnothing$  0.2 mm x 0.8 mm

### Recommended accessories

Other models and accessories → [www.sick.com/W2000](http://www.sick.com/W2000)

	Brief description	Type	Part no.
<b>Mounting brackets and plates</b>			
	Universal mounting bracket for reflectors, steel, zinc coated	BEF-WN-REFX	2064574

# WL2000-M4320 | W2000

## COMPACT PHOTOELECTRIC SENSORS

	Brief description	Type	Part no.
Reflectors			
	Rectangular, screw connection, 51 mm x 61 mm, PMMA/ABS, Screw-on, 2 hole mounting	P250	5304812

## SICK AT A GLANCE

SICK is one of the leading manufacturers of intelligent sensors and sensor solutions for industrial applications. A unique range of products and services creates the perfect basis for controlling processes securely and efficiently, protecting individuals from accidents and preventing damage to the environment.

We have extensive experience in a wide range of industries and understand their processes and requirements. With intelligent sensors, we can deliver exactly what our customers need. In application centers in Europe, Asia and North America, system solutions are tested and optimized in accordance with customer specifications. All this makes us a reliable supplier and development partner.

Comprehensive services complete our offering: SICK LifeTime Services provide support throughout the machine life cycle and ensure safety and productivity.

For us, that is “Sensor Intelligence.”

## WORLDWIDE PRESENCE:

Contacts and other locations –[www.sick.com](http://www.sick.com)