



GL6L-N4211

G6

MINIATURE PHOTOELECTRIC SENSORS

SICK
Sensor Intelligence.



Illustration may differ



Ordering information

| Type | Part no. |
|------------|----------|
| GL6L-N4211 | 1109724 |

Other models and accessories → www.sick.com/G6

Detailed technical data

Features

| | |
|---|---|
| Functional principle | Photoelectric retro-reflective sensor |
| Sensing range | |
| Sensing range min. | 0.08 m |
| Sensing range max. | 12 m |
| Maximum distance range from reflector to sensor (operating reserve 1) | 0.08 m ... 12 m |
| Recommended distance range from reflector to sensor (operating reserve 2) | 0.08 m ... 10 m |
| Reference reflector | Reflector P250F |
| Recommended sensing range for the best performance | 0.08 m ... 4.2 m |
| Polarisation filters | Yes |
| Emitted beam | |
| Light source | Laser |
| Type of light | Visible red light |
| Shape of light spot | Point-shaped |
| Light spot size (distance) | Ø 3.5 mm (1,000 mm) |
| Maximum dispersion of the emitted beam around the standardized transmission axis (squint angle) | < +/- 1.5° (at T _a = +23 °C) |
| Key laser figures | |
| Normative reference | IEC 60825-1 / CDRH 21 CFR 1040.10 & 1040.11 |
| Laser class | 1 |
| Wave length | 680 nm |
| Pulse duration | 2 µs |
| Maximum pulse power | ≤ 11.9 mW |
| Average service life | 100,000 h at T _a = +25 °C |
| Smallest detectable object (MDO) typ. | |

| | | |
|-------------------|-----------------------|---|
| | | 3.5 mm (at 1 m distance (object with 90% remission (corresponds on standard white DIN 5033))) |
| Adjustment | Potentiometer | For setting the sensing range |
| | Operating mode switch | For inverting the switching function (light/dark switching) |
| Indication | LED green | Operating indicator Static on: power on |
| | LED yellow | Status of received light beam Static on: object not present Static off: object present |

Safety-related parameters

| | |
|-------------------------------------|-----------------------|
| MTTF_D | 1,005 years |
| DC_{avg} | 0 % |
| T_M (mission time) | 10 years (EN 60825-1) |

Electrical data

| | | |
|---------------------------------------|--|--|
| Supply voltage U_B | 10 V DC ... 30 V DC ¹⁾ | |
| Ripple | < 5 V _{pp} | |
| Usage category | DC-13 (According to EN 60947-5-2) | |
| Current consumption | ≤ 20 mA, without load. At U _B = 24 V | |
| Protection class | III | |
| Digital output | Number | 1 |
| | Type | NPN |
| | Signal voltage NPN HIGH/LOW | Approx. U _B / ≤ 3 V |
| | Output current I _{max.} | ≤ 100 mA ²⁾ |
| | Circuit protection outputs | Reverse polarity protected Overcurrent protected Short-circuit protected |
| | Response time | ≤ 625 μs |
| | Switching frequency | 1,000 Hz ³⁾ |
| Pin/Wire assignment | | |
| Function of pin 4/black (BK) | Digital output, light switching, object present → output Q HIGH | |
| Function of pin 4/black (BK) – detail | The pin 4 function of the sensor can be switched, Additional possible settings via operating mode switch | |

¹⁾ Limit values.

²⁾ At U_B > 24 V, I max. = 50 mA.

³⁾ With light/dark ratio 1:1.

Mechanical data

| | |
|-------------------------------|--------------------------|
| Housing | Rectangular |
| Dimensions (W x H x D) | 12 mm x 31.5 mm x 21 mm |
| Connection | Male connector M8, 4-pin |
| Material | |
| Housing | Plastic, ABS |

| | |
|----------------|--------------------------------|
| Front screen | Plastic, PMMA |
| Cable | PVC |
| Male connector | Copper alloy (C3604 CUZN39PB3) |
| Weight | Approx. 60 g |

Ambient data

| | |
|--|---|
| Enclosure rating | IP67 (EN 60529) |
| Ambient operating temperature | -20 °C ... +50 °C ^{1) 2)} |
| Ambient temperature, storage | -40 °C ... +70 °C |
| Typ. Ambient light immunity | Sunlight: ≤ 13,000 lx |
| Shock resistance | 30 g, 11 ms (3 positive and 3 negative shocks along X, Y, Z axes, 18 total shocks (EN60068-2-27)) |
| Vibration resistance | 10 Hz ... 55 Hz (Amplitude 0.5 mm, 3x30 min (EN60068-2-6)) |
| Air humidity | 35 % ... 95 %, Relative humidity (no condensation) |
| Electromagnetic compatibility (EMC) | EN 60947-5-2 |
| UL File No. | NRKH.E348498 & NRKH7.E348498 |

¹⁾ As of $T_a \Rightarrow 45 \text{ °C}$, a max. supply voltage $U_B = 24 \text{ V}$ and a max. load current $I_{max.} = 50 \text{ mA}$ is permitted.

²⁾ Below $T_a = -20 \text{ °C}$ a warm-up time of 3 seconds is required.

Classifications

| | |
|-----------------------|----------|
| ECLASS 5.0 | 27270902 |
| ECLASS 5.1.4 | 27270902 |
| ECLASS 6.0 | 27270902 |
| ECLASS 6.2 | 27270902 |
| ECLASS 7.0 | 27270902 |
| ECLASS 8.0 | 27270902 |
| ECLASS 8.1 | 27270902 |
| ECLASS 9.0 | 27270902 |
| ECLASS 10.0 | 27270902 |
| ECLASS 11.0 | 27270902 |
| ECLASS 12.0 | 27270902 |
| ETIM 5.0 | EC002717 |
| ETIM 6.0 | EC002717 |
| ETIM 7.0 | EC002717 |
| ETIM 8.0 | EC002717 |
| UNSPSC 16.0901 | 39121528 |

Adjustments

Display and adjustment elements

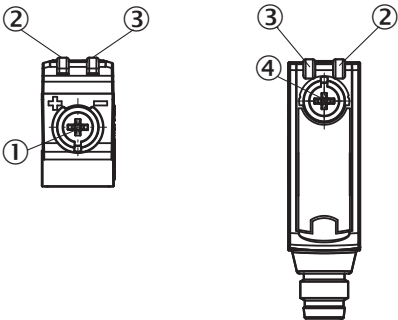

- ① Potentiometer
- ② LED yellow
- ③ LED green
- ④ Operating mode switch

Connection type

Male connector M8, 4-pin

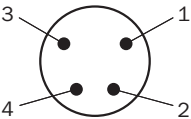

Connection diagram

Cd-066

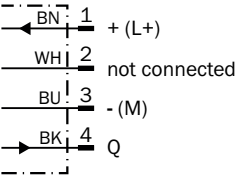

Truth table

NPN - light switching

| | Light switching Q (normally closed) | |
|-------------------------|-------------------------------------|------------------------------|
| | Object not present → Output LOW | Object present → Output HIGH |
| Light receive | ✓ | ✗ |
| Light receive indicator | ☀ | ✗ |
| Load resistance | ⚠ | ✗ |
| | | |

NPN - dark switching

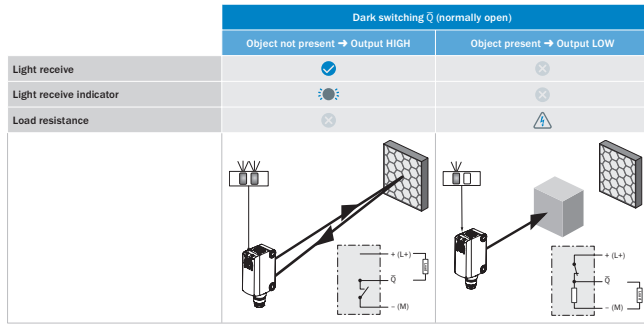

Characteristic curve

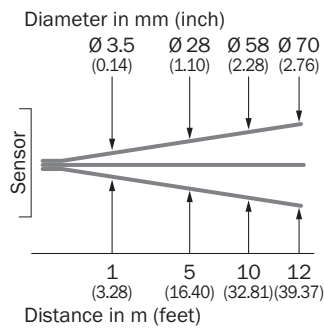

Operating reserve

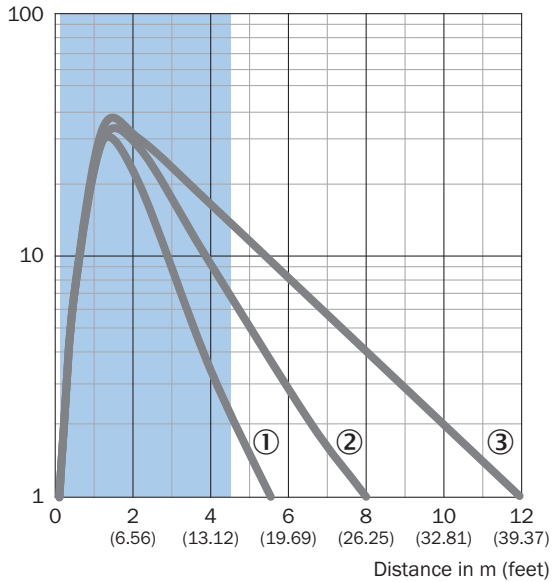

Recommended sensing range for the best performance

- ① PL10F reflector
- ② Reflector PL20F
- ③ Reflector P250F

Sensing range diagram

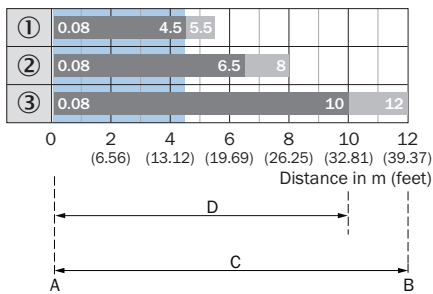

- A = Sensing range min. in m
- B = Sensing range max. in m
- C = Maximum distance range from reflector to sensor (operating reserve 1)
- D = Recommended distance range from reflector to sensor (operating reserve 2)

Recommended sensing range for the best performance

- ① PL10F reflector
- ② Reflector PL20F
- ③ Reflector P250F

Dimensional drawing (Dimensions in mm (inch))

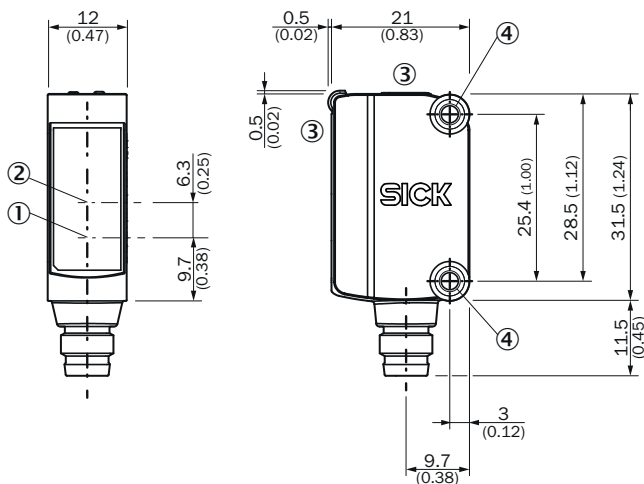



- ① Center of optical axis, sender
- ② Center of optical axis, receiver
- ③ Display and adjustment elements
- ④ Mounting holes M3

Recommended accessories

Other models and accessories → www.sick.com/G6

| | Brief description | Type | Part no. |
|---|--|----------------|----------|
| Universal bar clamp systems | | | |
|  | Clamp bar to fix G6 sensors on rods of 12 mm, clamp-on design up to 4 mm wall thickness, aluminum (clamp bar), stainless steel (bracket), clamp bar mounting and clamp function, mounting bracket, mounting hardware | BEF-KHS-IS12G6 | 2086865 |

| | Brief description | Type | Part no. |
|---|--|-----------|----------|
| Mounting brackets and plates | | | |
|  | Stainless steel (1.4301) | BEF-WN-G6 | 2062909 |
| Reflectors | | | |
|  | Fine triple reflector, screw connection, suitable for laser sensors, 20 mm x 60 mm, PM-MA/ABS, Screw-on, 2 hole mounting | PL20F | 5308844 |

SICK AT A GLANCE

SICK is one of the leading manufacturers of intelligent sensors and sensor solutions for industrial applications. A unique range of products and services creates the perfect basis for controlling processes securely and efficiently, protecting individuals from accidents and preventing damage to the environment.

We have extensive experience in a wide range of industries and understand their processes and requirements. With intelligent sensors, we can deliver exactly what our customers need. In application centers in Europe, Asia and North America, system solutions are tested and optimized in accordance with customer specifications. All this makes us a reliable supplier and development partner.

Comprehensive services complete our offering: SICK LifeTime Services provide support throughout the machine life cycle and ensure safety and productivity.

For us, that is “Sensor Intelligence.”

WORLDWIDE PRESENCE:

Contacts and other locations –www.sick.com