



TIM781S-2174104

TiM

2D LIDAR SENSORS

SICK
Sensor Intelligence.



Ordering information

| Type | Part no. |
|-----------------|----------|
| TIM781S-2174104 | 1096363 |

Other models and accessories → www.sick.com/TiM



Detailed technical data

Features

| | |
|-------------------------------------|--|
| Application | Indoor |
| System part | sensor |
| Measurement principle | HDDM ⁺ |
| Light source | Infrared (850 nm) |
| Laser class | 1 (IEC 60825-1:2014, EN 60825-1:2014+A11:2021) |
| Aperture angle | Horizontal 270° |
| Scanning frequency | 15 Hz |
| Angular resolution | Horizontal 0.33° |
| Scan field flatness | ± 1.5° |
| Working range | 0.05 m ... 25 m (> 90% remission) |
| Safety-related working range | 0.05 m ... 5 m (At 5% remission) |
| Blind zone | 0 m ... 0.05 m |
| Scanning range | At 10% remission factor 8 m |

Mechanics/electronics

| | |
|--------------------------|---|
| Connection type | 1 x "Ethernet" connection, 4-pin M12 female connector 1 x connection "Power", 12-pin, M12 male connector 1 x Micro USB female connector, type B |
| Supply voltage | 9 V DC ... 28 V DC |
| Power consumption | Typ. 4 W, 16 W with 4 max. loaded digital outputs |
| Output current | ≤ 100 mA |
| Housing color | Yellow |

| | |
|-------------------------------|---|
| Enclosure rating | IP67, applies only when the plastic cover of the "Aux interface" is closed (IEC 60529:1989+AMD1:1999+AMD2:2013) |
| Protection class | III (IEC 61140:2016-1) |
| Weight | 250 g, without connecting cables |
| Dimensions (L x W x H) | 60 mm x 60 mm x 86 mm |
| MTBF | > 100 years |

Safety-related parameters

| | |
|-------------------------------------|---|
| Category | B (EN ISO 13849-1:2015) |
| Performance level | PL b (EN ISO 13849-1:2015) |
| Performance class SRS/SRSS | B (IEC TS 62998-1:2019) |
| T_M (mission time) | 20 years (EN ISO 13849-1:2015) |
| Conformities | EN ISO 13849-1:2015, ANSI/ITSDF B56.5:2012, IEC TS 62998-1:2019, EN ISO 13482:2014, EN ISO 13855:2010 |
| MTF_D | 100 years, at 25 °C ambient temperature (EN ISO 13849-1:2015) |

Performance

| | |
|---|--|
| Response time | 1 scan, typ. 67 ms 2 scans, ≤ 134 ms ¹⁾ |
| Detectable object shape | Almost any |
| Systematic error | ± 60 mm ²⁾ |
| Statistical error | < 20 mm ²⁾ |
| Safety-related statistical error | < 100 mm (4,4 σ) |
| Integrated application | Protective field evaluation with flexible fields Output of measurement data |
| Protective field tolerance | 100 mm, 0.66° (DIN CLC/TS 62046:2009, 5% remission) |
| Number of field sets | 16 field triples (48 protective fields) |
| Simultaneous evaluation cases | 3 simultaneous protective fields (per field set) |

¹⁾ At +45° to +225° of the working range; max. 150 ms at -45° to +45° of the working range.

²⁾ Typical value at 90% remission up to maximum scanning range; real value depends on ambient conditions.

Interfaces

| | |
|---------------------------|--|
| Ethernet | ✓, TCP/IP |
| USB | ✓ |
| | Remark Micro USB |
| | Function Parameterization |
| Digital inputs | 4 (PNP, for field set switching) |
| Digital outputs | 3 (PNP, to display a detection in the protective field, additional 1 x "Device Ready") |
| Delay time | 67 ms ... 30,000 ms (configurable) |
| Dwell time | 67 ms ... 600,052 ms (configurable) |
| Optical indicators | 2 LEDs (ON, "device ready") |

Ambient data

| | |
|--|---|
| Object remission | ≥ 5 % (reflectors) ¹⁾ |
| Electromagnetic compatibility (EMC) | |
| Emitted radiation | Residential area (IEC 61000-6-3:2006+AMD1:2010) |
| Electromagnetic immunity | Industrial environment (IEC 61000-6-2:2005) |
| Vibration resistance | |
| Sine resonance scan | 10 Hz ... 1,000 Hz ²⁾ |
| Sine test | 10 Hz ... 500 Hz, 5 g, 10 frequency cycles ²⁾ |
| Noise test | 10 Hz ... 250 Hz, 4.24 g RMS, 5 h ³⁾ |
| Shock resistance | 50 g, 11 ms, ± 3 single shocks/axis ⁴⁾ 25 g, 6 ms, ± 1,000 continuous shocks/axis ⁴⁾ 50 g, 3 ms, ± 5,000 continuous shocks/axis ⁴⁾ |
| Ambient operating temperature | -25 °C ... +50 °C ⁵⁾ |
| Storage temperature | -40 °C ... +75 °C ⁵⁾ |
| Switch-on temperature | -10 °C ... +50 °C |
| Temperature change | -25 °C ... +50 °C, 10 cycles ⁶⁾ |
| Damp heat | +25 °C ... +55 °C, 95 % RH, 6 cycles ⁷⁾ |
| Permissible relative humidity | |
| Operation | < 80 %, Non-condensing (EN 60068-2-30:2005) |
| Storage | ≤ 90 %, Non-condensing (EN 60068-2-30:2005) |
| Ambient light immunity | 80,000 lx 3,000 lx, With direct light |

¹⁾ When using reflectors, observe notes in the operating instructions.

²⁾ IEC 60068-2-6:2007.

³⁾ IEC 60068-2-64:2008.

⁴⁾ IEC 60068-2-27:2008.

⁵⁾ IEC 60068-2-14:2009.

⁶⁾ EN 60068-2-14:2009.

⁷⁾ EN 60068-2-30:2005.

General notes

| | |
|--------------------|--|
| Note on use | The TIM781S is a safety-related sensor that is suitable for use in the following applications: Hazardous area, hazardous point, and access protection as well as mobile hazardous area protection (protection of automated guided vehicles and mobile platforms). The sensor must only ever be used within the limits of the prescribed and specified technical data and operating conditions. |
|--------------------|--|

Classifications

| | |
|---------------------|----------|
| ECLASS 5.0 | 27270990 |
| ECLASS 5.1.4 | 27270990 |
| ECLASS 6.0 | 27270913 |
| ECLASS 6.2 | 27270913 |
| ECLASS 7.0 | 27270913 |
| ECLASS 8.0 | 27270913 |
| ECLASS 8.1 | 27270913 |
| ECLASS 9.0 | 27270913 |

| | |
|-----------------------|----------|
| ECLASS 10.0 | 27270913 |
| ECLASS 11.0 | 27270913 |
| ECLASS 12.0 | 27270913 |
| ETIM 5.0 | EC002550 |
| ETIM 6.0 | EC002550 |
| ETIM 7.0 | EC002550 |
| ETIM 8.0 | EC002550 |
| UNSPSC 16.0901 | 41111615 |

Dimensional drawing (Dimensions in mm (inch))

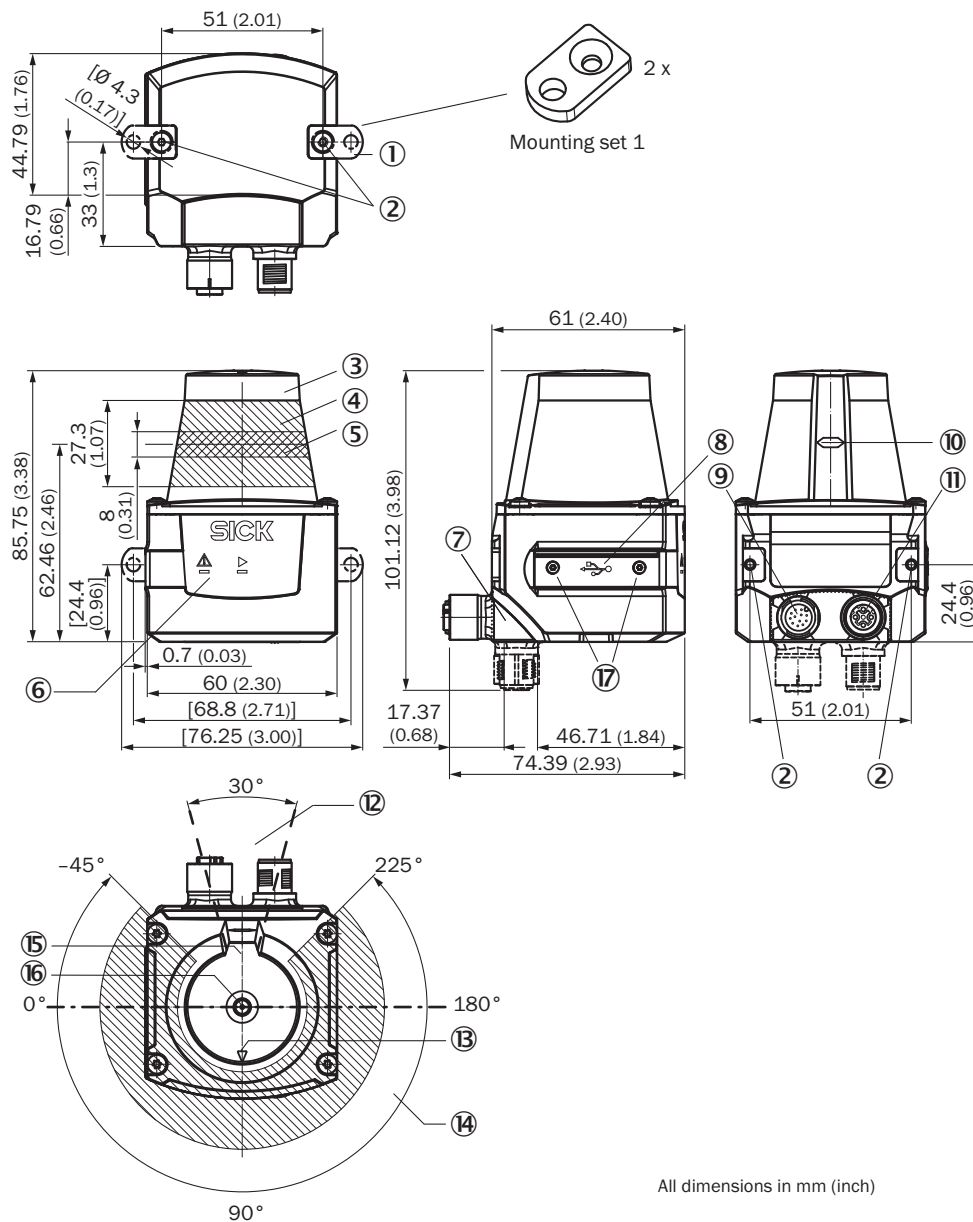

All dimensions in mm (inch)

- ① 2 x straight plates with M3 x 4 mm screw (included in delivery)
- ② M3 threaded mounting hole, 2.8 mm deep (blind hole thread), max. tightening torque 0.8 Nm
- ③ Optical hood
- ④ Receiving range (light inlet)
- ⑤ Transmission range (light emission)
- ⑥ Red and green LED (status displays)
- ⑦ Swivel connector unit
- ⑧ Micro USB port, behind the black rubber plate ("Aux interface" connection for configuration with PC)
- ⑨ "Power/inputs and outputs" connection, 12-pin M12 male connector
- ⑩ Marking for the position of the light emission level
- ⑪ 4-pin M12 female connector: not assigned
- ⑫ Area in which no reflective surfaces are allowed for mounted devices
- ⑬ Bearing marking to support alignment (90° axis)
- ⑭ Aperture angle 270° (scanning angle)
- ⑮ Internal reference target
- ⑯ Measurement origin
- ⑰ 2 x countersunk screw (Torx TX 6) M2 x 4 mm

Working range diagram

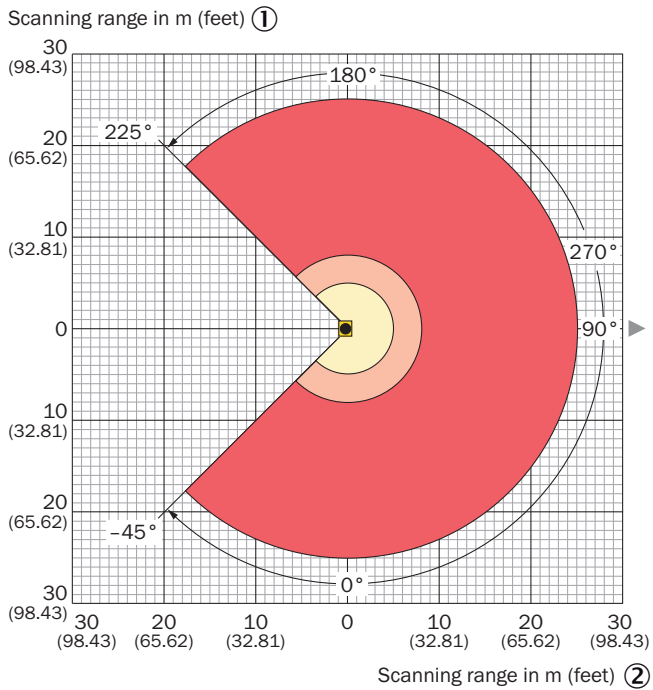

- Range for **not safety-related** detection at > 90% remission:
0.05 m (0.17 feet) to max. 25 m (82.02 feet) ③
- Range for **not safety-related** detection 10% remission:
0.05 m (0.17 feet) to max. 8 m (26.25 feet) ④
- Range for **safety-related** detection at 5% remission:
0.05 m (0.17 feet) to max. 5 m (16.40 feet) ⑤

Attention! From the measurement origin up to a distance of 0.05 m (0.17 feet) no objects are detected (blind zone!) over the entire radial field of view (scanning range of 270°). ⑥

- ① Scanning range in meters (feet)
- ② Scanning range in meters (feet)
- ③ Scanning range for non safety-related detection at > 90% remission: 0.05 m to max 25 m
- ④ Scanning range for non safety-related detection at > 10% remission: 0.05 m to max. 8 m
- ⑤ Scanning range for safety-related detection at 5% remission: 0.05 m to max. 5 m
- ⑥ **WARNING!** No objects will be detected within a range of 0.05 m from the measurement origin and across the entire radial field of view (scanning range of 270°) (blind zone!).

Connection type

Ethernet

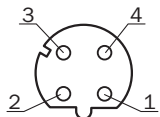

M12 female connector, 4-pin, D-coded

- ① TX+
- ② RX+
- ③ TX-
- ④ RX-

PIN assignment

Power I/O connection

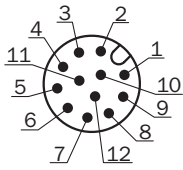



Connecting cable with male connector or M12 male connector, 12-pin, A-coded

- ① GND
- ② DC 9 V ... 28 V
- ③ In₁
- ④ In₂
- ⑤ OUT1
- ⑥ OUT2
- ⑦ OUT3
- ⑧ OUT4
- ⑨ PNP: INGND, NPN: IN 9 V ... 28 V
- ⑩ In3
- ⑪ In4
- ⑫ nc

Recommended accessories

Other models and accessories → www.sick.com/TiM

| | Brief description | Type | Part no. |
|---|---|-------------------|----------|
| Mounting brackets and plates | | | |
|  | <ul style="list-style-type: none"> • Description: Mounting kit with shock absorber • Material: Anodized aluminum • Details: Anodized aluminum • Items supplied: Mounting hardware included • Suitable for: TiM3xx, TiM5xx, TiM7xx | Mounting kit | 2086074 |
| Others | | | |
|  | <ul style="list-style-type: none"> • Connection type head A: Female connector, M12, 12-pin, straight, A-coded • Connection type head B: Flying leads • Signal type: Sensor/actuator cable • Cable: 10 m, 12-wire, PUR • Description: Sensor/actuator cable, Pin 1 and pin 2 swapped over, shielded • Connection systems: Flying leads | YF2A6B-100XXXLEAX | 6054973 |
|  | <ul style="list-style-type: none"> • Connection type head A: Male connector, Micro-B, 4-pin, straight • Connection type head B: Male connector, USB-A, 4-pin, straight • Signal type: USB 2.0 • Cable: 2 m, 4-wire • Description: USB 2.0, unshielded | USB cable | 6036106 |

Recommended services

Additional services → www.sick.com/TiM

| | Type | Part no. |
|---|--|----------|
| Maintenance | | |
| <ul style="list-style-type: none"> • Product area: 2D LiDAR sensors, 3D LiDAR sensors • Range of services: Inspection, analysis and restoring of defined functions, Inspection and adaptation of basic settings, parameters of field application, filters for raw data output, and product-specific configuration • Duration: Additional work will be invoiced separately | Maintenance of LiDAR sensors | 1682593 |
| Commissioning | | |
| <ul style="list-style-type: none"> • Product area: 2D LiDAR sensors, 3D LiDAR sensors • Range of services: Inspection of connection, fine adjustment, configuration of monitored areas, configuration and optimization of parameters as well as tests, Setup of previously defined functions of basic settings, parameters of field application, filters for raw data output and product-specific configuration • Duration: Additional work will be invoiced separately | Commissioning LiDAR sensors | 1680672 |
| Extended warranty | | |
| <ul style="list-style-type: none"> • Product area: Machine vision, LiDAR sensors, safety camera sensors, Safety laser scanners, Safety radar sensors, Radar sensors, Fixed mount barcode scanners, Image-based code readers, RFID, Mobile handheld scanners • Range of services: The services correspond to the scope of the statutory warranty (SICK General Terms of Delivery) • Duration: Five-year warranty from delivery date. | Extended warranty for a total of five years from delivery date | 1680671 |

SICK AT A GLANCE

SICK is one of the leading manufacturers of intelligent sensors and sensor solutions for industrial applications. A unique range of products and services creates the perfect basis for controlling processes securely and efficiently, protecting individuals from accidents and preventing damage to the environment.

We have extensive experience in a wide range of industries and understand their processes and requirements. With intelligent sensors, we can deliver exactly what our customers need. In application centers in Europe, Asia and North America, system solutions are tested and optimized in accordance with customer specifications. All this makes us a reliable supplier and development partner.

Comprehensive services complete our offering: SICK LifeTime Services provide support throughout the machine life cycle and ensure safety and productivity.

For us, that is “Sensor Intelligence.”

WORLDWIDE PRESENCE:

Contacts and other locations –www.sick.com