



# V3T13P-MR62A7

TriSpectorP1000

3D MACHINE VISION

**SICK**  
Sensor Intelligence.



### Ordering information

Type	Part no.
V3T13P-MR62A7	1091323

Other models and accessories → [www.sick.com/TriSpectorP1000](http://www.sick.com/TriSpectorP1000)



### Detailed technical data

#### Features

<b>Task</b>	Detecting - Standard objects Detecting - Level Measuring - Dimension, contour and volume Measuring - Number Monitoring and controlling - Quality Determining position - 3D position determination
<b>Technology</b>	3D triangulation
<b>Product category</b>	Programmable
<b>Toolkit</b>	SICK algorithm API HALCON
<b>Working distance</b>	291 mm ... 1,091 mm
<b>Example field of view</b>	540 mm x 200 mm
<b>Illumination</b>	Integrated
<b>Illumination color</b>	Red, laser, Visible, 660 nm, ± 7 nm
<b>Laser class</b>	2 (EN 60825-1:2014+A11:2021; IEC 60825-1:2014, Complies with the FDA performance requirements for laser products except for conformance with IEC 60825-1 Ed.3., as described in Laser Notice 56 dated May 8, 2019.)
<b>Factory calibrated</b>	✓
<b>Width at minimum operating distance</b>	180 mm
<b>Width at maximum operating distance</b>	660 mm
<b>Maximum height range</b>	800 mm
<b>Imaging angle</b>	67°
<b>Offline support</b>	Emulator

#### Mechanics/electronics

<b>Connection type</b>	M12, 12-pin male connector, A-coded (voltage supply, I/O) M12, 8-pin female connector, X-coded (Gigabit Ethernet)
------------------------	--

	M12, 8-pin female connector, A-coded (encoder)
<b>Connector material</b>	Nickel plated brass
<b>Supply voltage</b>	24 V, ± 20 %
<b>Ripple</b>	< 5 V <sub>pp</sub>
<b>Power consumption</b>	≤ 11 W
<b>Current consumption</b>	< 400 mA, without output load
<b>Enclosure rating</b>	IP67
<b>Protection class</b>	III
<b>Housing material</b>	Anodized aluminum
<b>Window material</b>	Glass
<b>Weight</b>	1.7 kg
<b>Dimensions (L x W x H)</b>	307 mm x 62 mm x 84 mm

### Performance

<b>Scan/frame rate</b>	5,000 3D profiles/s
<b>Maximum number of profiles</b>	2,500 Per image
<b>Data points/profile</b>	1,536
<b>Height resolution</b>	80 µm ... 670 µm
<b>3D profile resolution</b>	0.43 mm/px

### Interfaces

<b>Ethernet</b>	✓, TCP/IP
Function	FTP, HTTP
Data transmission rate	≤ 1,000 Mbit/s
<b>Serial</b>	✓, RS-232, RS-422
<b>Operator interfaces</b>	Web server
<b>Configuration software</b>	SICK AppStudio
<b>Digital input</b>	3 inputs
<b>Configurable outputs</b>	4 inputs/outputs
<b>Encoder interface</b>	RS-422 / TTL
<b>Maximum encoder frequency</b>	300 kHz

### Ambient data

<b>Electromagnetic compatibility (EMC)</b>	EN 61000-6-2:2005 / EN 61000-6-3:2007
<b>Shock load</b>	15 g / 6 ms (EN 60068-2-27)
<b>Vibration load</b>	5 g, 10 Hz ... 150 Hz (EN 60068-2-6)
<b>Ambient operating temperature</b>	0 °C ... +50 °C
<b>Storage temperature</b>	-20 °C ... +70 °C

### Classifications

<b>ECLASS 5.0</b>	27310205
<b>ECLASS 5.1.4</b>	27310205
<b>ECLASS 6.0</b>	27310205
<b>ECLASS 6.2</b>	27310205
<b>ECLASS 7.0</b>	27310205

<b>ECLASS 8.0</b>	27310205
<b>ECLASS 8.1</b>	27310205
<b>ECLASS 9.0</b>	27310205
<b>ECLASS 10.0</b>	27310205
<b>ECLASS 11.0</b>	27310205
<b>ECLASS 12.0</b>	27310205
<b>ETIM 5.0</b>	EC001820
<b>ETIM 6.0</b>	EC001820
<b>ETIM 7.0</b>	EC001820
<b>ETIM 8.0</b>	EC001820
<b>UNSPSC 16.0901</b>	43211731

### Dimensional drawing (Dimensions in mm (inch))

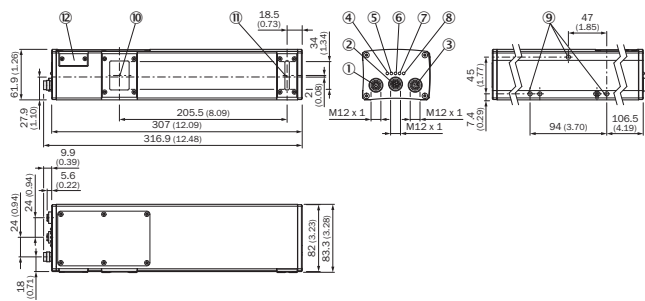

- ① Connector Encoder (thread inside)
- ② Connector Gigabit Ethernet (Gig E)
- ③ Connector Power I/O (thread inside)
- ④ LED; On
- ⑤ LED; State
- ⑥ LED; Link/Data
- ⑦ LED; Result
- ⑧ LED; Laser
- ⑨ Fastening threads (M5 x 8.5 mm length)
- ⑩ Optical receiver (center)
- ⑪ Optical sender (center)
- ⑫ Micro SD memory card

### Field of view

#### TriSpectorP1060

Typ. field of view in mm (inch)

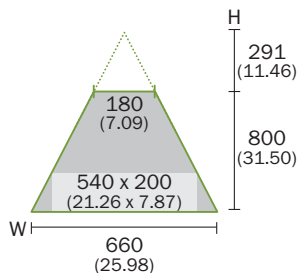

### Typical field of view

TriSpectorP1000



Y = Max. height range  
X = Width at max.  
working distance

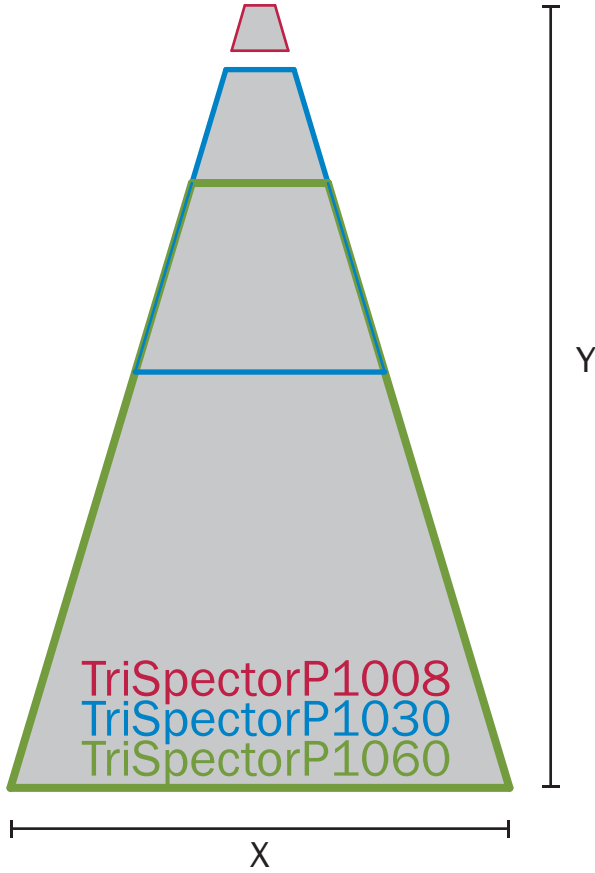



### Overview

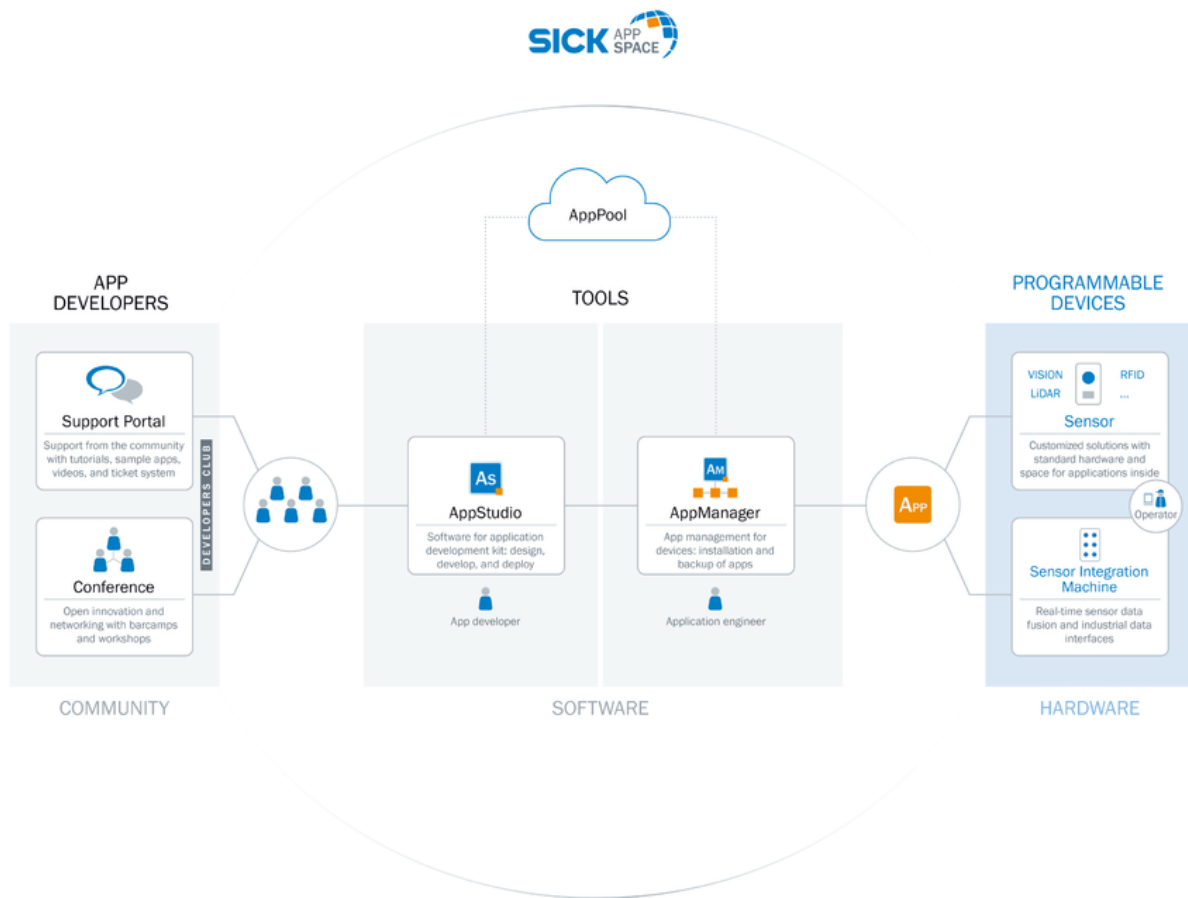



SICK AppSpace



### Recommended accessories

Other models and accessories → [www.sick.com/TriSpectorP1000](http://www.sick.com/TriSpectorP1000)

	Brief description	Type	Part no.
<b>Mounting brackets and plates</b>			
	Mounting bracket set consisting of mounting bracket, cooling plate, includes angle display for setting the tilt angle	Mounting bracket	2076735
<b>Others</b>			
	<ul style="list-style-type: none"> <li>• <b>Connection type head A:</b> Male connector, M12, 5-pin, straight</li> <li>• <b>Connection type head B:</b> Flying leads</li> <li>• <b>Cable:</b> 2 m</li> <li>• <b>Description:</b> Shielded</li> <li>• <b>Connection systems:</b> Flying leads</li> </ul>	Connecting cable	6024860

	Brief description	Type	Part no.
	<ul style="list-style-type: none"> <li><b>Connection type head A:</b> Female connector, M12, 12-pin, straight</li> <li><b>Connection type head B:</b> Male connector, M12, 5-pin, straight</li> <li><b>Signal type:</b> Power</li> <li><b>Cable:</b> 0.25 m</li> <li><b>Description:</b> Power, Cable for connecting a TriSpector to power supply unit 2079609</li> </ul>	YF2A6B-C25XXXM2A15	2079766
	<ul style="list-style-type: none"> <li><b>Connection type head A:</b> Female connector, M12, 8-pin, straight, A-coded</li> <li><b>Connection type head B:</b> Male connector, M12, 8-pin, straight, A-coded</li> <li><b>Signal type:</b> Sensor/actuator cable</li> <li><b>Cable:</b> 2 m, 8-wire, PUR, halogen-free</li> <li><b>Description:</b> Sensor/actuator cable, shielded</li> <li><b>Application:</b> Zones with oils and lubricants, Drag chain operation</li> </ul>	YF2A28-020UA6M2A28	2096105
	<ul style="list-style-type: none"> <li><b>Connection type head A:</b> Male connector, M12, 8-pin, straight, A-coded</li> <li><b>Connection type head B:</b> Flying leads</li> <li><b>Signal type:</b> Sensor/actuator cable</li> <li><b>Cable:</b> 5 m, 8-wire, PVC</li> <li><b>Description:</b> Sensor/actuator cable, shielded</li> <li><b>Application:</b> Zones with chemicals</li> </ul>	YM2A28-050VA6XLEAX	2096233
	<ul style="list-style-type: none"> <li><b>Connection type head A:</b> Male connector, M12, 8-pin, straight, X-coded</li> <li><b>Connection type head B:</b> Male connector, RJ45, 8-pin, straight</li> <li><b>Signal type:</b> Ethernet, Gigabit Ethernet</li> <li><b>Cable:</b> 2 m, 8-wire, PUR, halogen-free</li> <li><b>Description:</b> Ethernet, Gigabit Ethernet, shielded</li> <li><b>Application:</b> Zones with oils and lubricants</li> </ul>	YM2X18-020EG1MRJA8	2106258
Incremental encoders			
	<ul style="list-style-type: none"> <li><b>Mechanical design:</b> Solid shaft face mount flange 10 mm x 19 mm</li> <li><b>Communication interface:</b> 4.5 V ... 32 V, TTL, HTL, programmable</li> <li><b>Connection type:</b> Male connector, M12, 8-pin, radial</li> <li><b>Pulses per revolution:</b> 10,000</li> </ul>	DFS60B-S4PC10000	1036721

### Recommended services

Additional services → [www.sick.com/TriSpectorP1000](http://www.sick.com/TriSpectorP1000)

	Type	Part no.
Extended warranty		
<ul style="list-style-type: none"> <li><b>Product area:</b> Machine vision, LiDAR sensors, safety camera sensors, Safety laser scanners, Safety radar sensors, Radar sensors, Fixed mount barcode scanners, Image-based code readers, RFID, Mobile handheld scanners</li> <li><b>Range of services:</b> The services correspond to the scope of the statutory manufacturer warranty (SICK general terms of delivery).</li> <li><b>Duration:</b> Five-year warranty from delivery date.</li> </ul>	Extended warranty for a total of five years from delivery date	1680671

## SICK AT A GLANCE

SICK is one of the leading manufacturers of intelligent sensors and sensor solutions for industrial applications. A unique range of products and services creates the perfect basis for controlling processes securely and efficiently, protecting individuals from accidents and preventing damage to the environment.

We have extensive experience in a wide range of industries and understand their processes and requirements. With intelligent sensors, we can deliver exactly what our customers need. In application centers in Europe, Asia and North America, system solutions are tested and optimized in accordance with customer specifications. All this makes us a reliable supplier and development partner.

Comprehensive services complete our offering: SICK LifeTime Services provide support throughout the machine life cycle and ensure safety and productivity.

For us, that is “Sensor Intelligence.”

## WORLDWIDE PRESENCE:

Contacts and other locations –[www.sick.com](http://www.sick.com)