



SEL37-HFA0-K02

SEK/SEL

MOTOR FEEDBACK SYSTEMS

SICK
Sensor Intelligence.

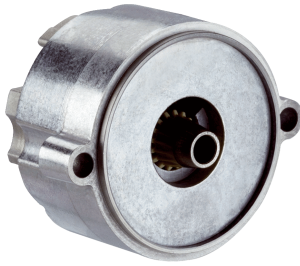

Illustration may differ



Ordering information

Type	Part no.
SEL37-HFA0-K02	1037377

Other models and accessories → www.sick.com/SEK_SEL

Detailed technical data

Safety-related parameters

MTTF_D (mean time to dangerous failure)	275 years (EN ISO 13849) ¹⁾
--	--

¹⁾ This product is a standard product and does not constitute a safety component as defined in the Machinery Directive. Calculation based on nominal load of components, average ambient temperature 60 °C, frequency of use 8760 h/a. All electronic failures are considered hazardous. For more information, see document no. 8015532.

Performance

Sine/cosine periods per revolution	16
Number of the absolute ascertainable revolutions	4,096
Maximum number of steps per revolution	512 via RS485
Total number of steps	2,097,152
Measuring step	20 " For interpolation of the sine/cosine signals with, e. g., 12 bits
Integral non-linearity	± 288 ", Error limits for evaluating sine/cosine period Typical values at nominal position ± 0.1 mm und +20 °C
Differential non-linearity	± 144 ", Non-linearity within a sine/cosine period, typical values at nominal position ± 0.1 mm und +20 °C
Operating speed	≤ 6,000 min ⁻¹ , up to which the absolute position can be reliably produced
Available memory area	1,792 Byte
System accuracy	± 432 "

Interfaces

Type of code for the absolute value	Binary
Code sequence	Increasing, when turning the shaft For clockwise rotation, looking in direction "A" (see dimensional drawing), For clockwise shaft rotation, looking in direction "A" (see dimensional drawing)
Communication interface	HIPERFACE®

Electrical data

Connection type	Male connector, 8-pin, axial
Supply voltage	7 V DC ... 12 V DC
Recommended supply voltage	8 V DC
Current consumption	< 50 mA ¹⁾

¹⁾ Without load.

Mechanical data

Shaft version	Tapered shaft
Dimensions	See dimensional drawing
Weight	≤ 0.05 kg
Moment of inertia of the rotor	1 gcm ²
Operating speed	12,000 min ⁻¹ , 12,000 U/min
Angular acceleration	≤ 500,000 rad/s ²
Permissible radial shaft movement	± 0.15 mm
Permissible axial shaft movement	± 0.3 mm

Ambient data

Operating temperature range	-20 °C ... +115 °C
Storage temperature range	-50 °C ... +125 °C, without package
Relative humidity/condensation	90 %, Condensation not permitted
Resistance to shocks	100 g, 10 ms (according to EN 60068-2-27)
Frequency range of resistance to vibrations	50 g, 10 Hz ... 2,000 Hz (EN 60068-2-6)
EMC	According to EN 61000-6-2 and EN 61000-6-3 ¹⁾
Enclosure rating	IP40, built-on version, with mating connector inserted and closed cover (IEC 60529)

¹⁾ The EMC according to the standards quoted is achieved when the motor feedback system is mounted in an electrically conductive housing, which is connected to the central earthing point of the motor controller via a cable screen. If other shielding concepts are used, users must perform their own tests.

Classifications

ECLASS 5.0	27270590
ECLASS 5.1.4	27270590
ECLASS 6.0	27270590
ECLASS 6.2	27270590
ECLASS 7.0	27270590
ECLASS 8.0	27270590
ECLASS 8.1	27270590
ECLASS 9.0	27270590
ECLASS 10.0	27273805
ECLASS 11.0	27273901
ECLASS 12.0	27273901
ETIM 5.0	EC001486
ETIM 6.0	EC001486
ETIM 7.0	EC001486
ETIM 8.0	EC001486
UNSPSC 16.0901	41112113

Dimensional drawing (Dimensions in mm (inch))

General tolerances according to DIN ISO 2768-mk

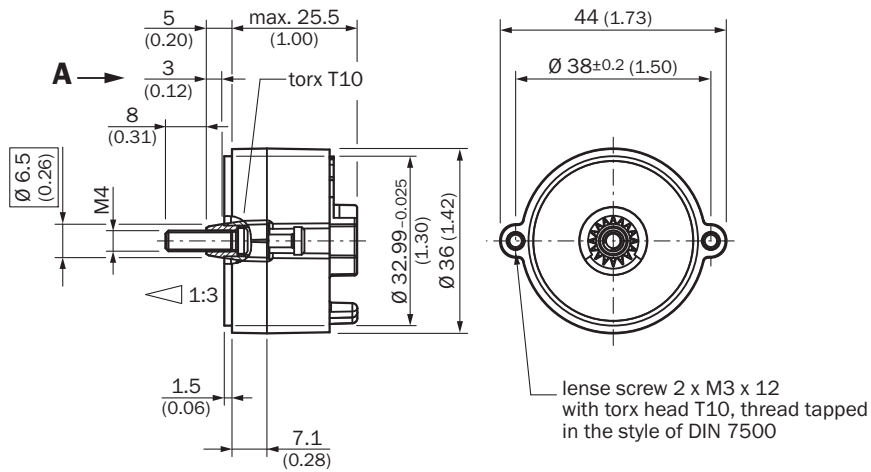

Axial

Attachment specifications

General tolerances according to DIN ISO 2768-mk

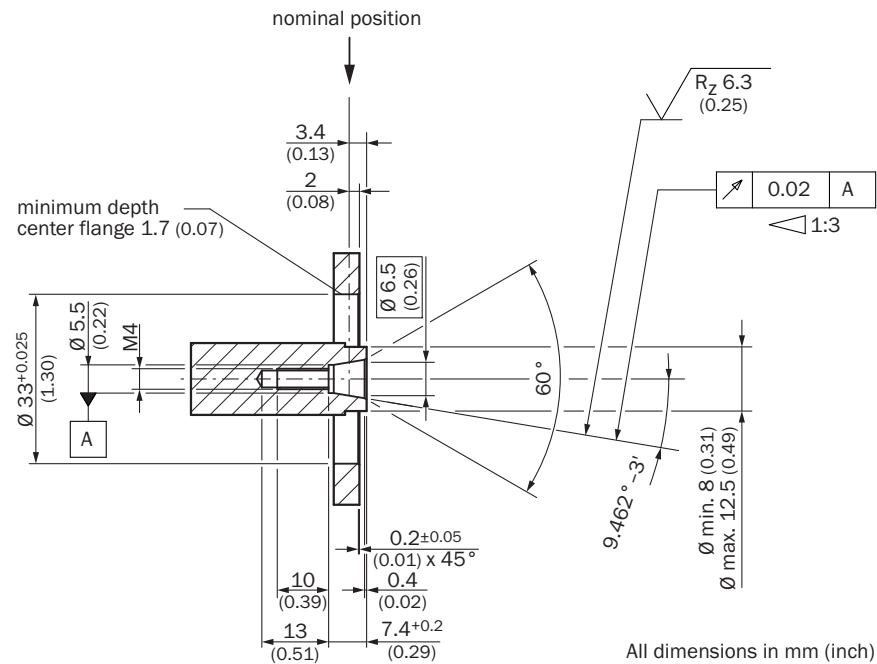

Axial

All dimensions in mm (inch)

PIN assignment

View of the plug-in face

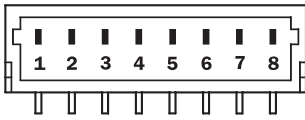

PIN	Signal	Wire colors (cable connection)	Explanation
1	U _S	Red	Supply voltage
2	+ SIN	White	Process data channel
3	REFSIN	Brown	Process data channel
4	+ COS	Pink	Process data channel
5	REFCOS	Black	Process data channel
6	GND	Blue	Ground connection
7	Data +	Gray or yellow	Parameter channel RS 485
8	Data -	Green or purple	Parameter channel RS 485

The GND connection (0 V) of the supply voltage is not connected to the housing

Diagrams

Signal diagram for clockwise shaft rotation, looking in direction "A" (see dimensional drawing) 1 period = 360° : 16

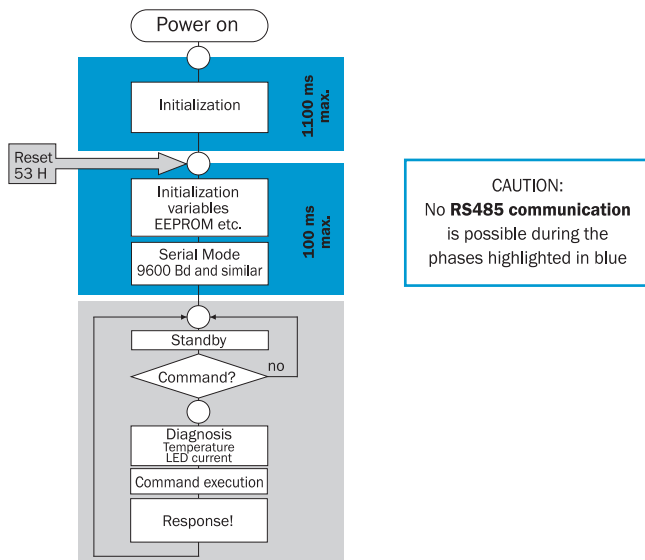
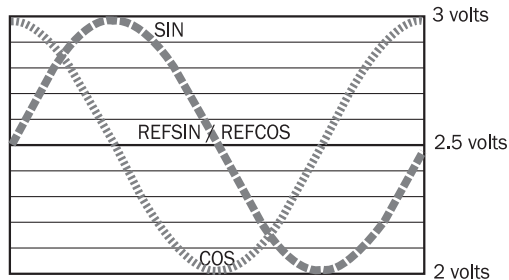

Operation note

Model-specific settings

Type-specific settings	SEK37	SEL37
Type ID (command 52h)	42h	47h
Free E ² PROM [bytes]	128/ 1792	128/ 1792
Address	40h	40h
Mode_485 ¹⁾²⁾	E4h	E4h
Codes 0 to 3	55h	55h
Counter	0	0

¹⁾ Default interface settings can not be changed (e.g. baudrate, timeout or parity bit)

²⁾ When using the motor feedback systems SEK|SEL37 please ensure that the controller's auto-baud function is not enabled, since these motor feedback systems compensate for minor variations when transmitting at a baud rate of 9600.

Overview of status messages for HIPERFACE®

	Status code	Description	SEK37	SEL37
Error type	00h	The encoder has not detected any faults	■	■
Initialization	01h	Incorrect alignment data	■	■
	02h	Incorrect internal angular offset	■	■
	03h	Data field partitioning table destroyed	■	■
	04h	Analog limit values not available	■	■
	05h	Internal I2C bus inoperative	■	■
	06h	Internal checksum error	■	■
Protocol	07h	Encoder reset occurred as a result of program monitoring	■	■
	09h	Parity error	■	■
	0Ah	Checksum of transmitted data is incorrect	■	■
	0Bh	Unknown command code	■	■
	0Ch	Number of transmitted data is incorrect	■	■
Data	0Dh	Transmitted command argument is not allowed	■	■
	0Eh	The selected data field may not be written to	■	■
	0Fh	Incorrect access code	■	■
	10h	Size of specified data field cannot be changed	■	■
	11h	Specified word address lies outside the data field	■	■
Position	12h	Access to non-existent data field	■	■
	1Fh	Speed too high, no position formation possible	■	■
	20h	Singleturn position unreliable	■	■
	21h	Multiturn position error		■
Other	22h	Multiturn position error		■
	23h	Multiturn position error		■
	1Ch	Value monitoring of the analog signals (process data)	■	■
	1Eh	Encoder temperature critical	■	■
	08h	Counter overflow	■	■

For more information on the interface see HIPERFACE® - description, part no. 8010701

Overview of supported commands for HIPERFACE®

Overview of supported commands			SEK37	SEL37
Command byte	Function	Code 0 ¹⁾	Comment	Comment
42h	Read position (5 bits per sine/cosine period)		9 bits	21 bits
43h	Set position	■		
44h	Read analog value		Channel number F0H ²⁾ 48h Temperature [°C]	Channel number F0H ²⁾ 48h Temperature [°C]
46h	Read counter			
47h	Increment Counter			
49h	Delete counter	■		
4Ah	Read data			
4Bh	Store data			
4Ch	Determine status of a data field			
4Dh	Create data field			
4Eh	Determine available memory area			
4Fh	Change access code			
50h	Read encoder status			
52h	Read out type label		Encoder type = 42h	Encoder type = 47h
53h	Encoder reset			
55h	Allocate encoder address	■		
56h	Read serial number and program version			

¹⁾ The commands thus labelled include the parameter "Code 0". Code 0 is a byte inserted into the protocol, for additional

²⁾ Temperature compatible with SCx (encoder temperature [°C] *2.048 – 40)

Characteristics applicable to all permissible environmental conditions

Signal	Values/unit
Signal peak, peak V_{SS} of SIN, COS	0.9 V ... 1.1 V
Signal offset REFSIN, REFCOS	2.2 V ... 2.8 V

Recommended accessories

Other models and accessories → www.sick.com/SEK_SEL

	Brief description	Type	Part no.
Others			
	<ul style="list-style-type: none"> • Connection type head A: Flying leads • Connection type head B: Flying leads • Signal type: HIPERFACE®, HIPERFACE® • Items supplied: By the meter • Cable: 8-wire, PUR, halogen-free • Description: HIPERFACE®, HIPERFACE®, shielded 	LTG-2708-MW	6028361
		DOL-0J08-G0M2XB6	2031086

SICK AT A GLANCE

SICK is one of the leading manufacturers of intelligent sensors and sensor solutions for industrial applications. A unique range of products and services creates the perfect basis for controlling processes securely and efficiently, protecting individuals from accidents and preventing damage to the environment.

We have extensive experience in a wide range of industries and understand their processes and requirements. With intelligent sensors, we can deliver exactly what our customers need. In application centers in Europe, Asia and North America, system solutions are tested and optimized in accordance with customer specifications. All this makes us a reliable supplier and development partner.

Comprehensive services complete our offering: SICK LifeTime Services provide support throughout the machine life cycle and ensure safety and productivity.

For us, that is “Sensor Intelligence.”

WORLDWIDE PRESENCE:

Contacts and other locations –www.sick.com