



# C40S-1003CD010

C4000 Palletizer

SAFETY LIGHT CURTAINS

**SICK**  
Sensor Intelligence.



Illustration may differ

### Ordering information

#### C4000 Palletizer Advanced

Resolution	Scanning range	Protective field height	System part	Type	Part no.
30 mm	7 m	1,050 mm	Sender	C40S-1003CD010	1041902

Other models and accessories → [www.sick.com/C4000\\_Palletizer](http://www.sick.com/C4000_Palletizer)



### Detailed technical data

#### Features

<b>Description</b>	C4000 Palletizer Advanced
<b>Application</b>	Normal industrial environment
<b>System part</b>	Sender
<b>Resolution</b>	30 mm
<b>Scanning range</b>	7 m
<b>Protective field height</b>	1,050 mm
<b>Synchronization</b>	Optical synchronisation
<b>Items supplied</b>	Sender

#### Safety-related parameters

<b>Type</b>	Type 4 (IEC 61496-1)
<b>Safety integrity level</b>	SIL 3 (IEC 61508)
<b>Category</b>	Category 4 (EN ISO 13849)
<b>Performance level</b>	PL e (EN ISO 13849)
<b>PFH<sub>D</sub> (mean probability of a dangerous failure per hour)</b>	$15 * 10^{-9}$
<b>T<sub>M</sub> (mission time)</b>	20 years (EN ISO 13849)
<b>Safe state in the event of a fault</b>	At least one OSSD is in the OFF state.

#### Functions

	Functions	Delivery status
<b>Function range</b>	Advanced	
<b>Protective operation</b>	✓	
<b>Beam coding</b>	✓	Code 1
<b>Configurable scanning range</b>	✓	0.5 m ... 7 m
<b>Safe SICK device communication via EFI</b>	✓	

#### Interfaces

<b>System connection</b>	Hirschmann male connector M26, 12-pin
--------------------------	---------------------------------------

<sup>1)</sup> Depending on load, power supply and wire cross-section. The technical specifications must be observed.

Direction of cable connection	Straight
Conductor cross section	0.75 mm <sup>2</sup>
Permitted cable length	≤ 50 m <sup>1)</sup>
<b>Display elements</b>	7-segment display

<sup>1)</sup> Depending on load, power supply and wire cross-section. The technical specifications must be observed.

## Electrical data

<b>Protection class</b>	III (IEC 61140)
<b>Supply voltage V<sub>S</sub></b>	24 V DC (19.2 V ... 28.8 V) <sup>1)</sup>
<b>Residual ripple</b>	≤ 10 % <sup>2)</sup>

<sup>1)</sup> The external voltage supply must be capable of buffering brief mains voltage failures of 20 ms as specified in EN 60204-1. Suitable power supplies are available as accessories from SICK.

<sup>2)</sup> Within the limits of V<sub>S</sub>.

## Mechanical data

<b>Dimensions</b>	See dimensional drawing
<b>Housing cross-section</b>	48 mm x 40 mm
<b>Housing material</b>	Aluminum extruded profile
<b>Weight</b>	2,250 g

## Ambient data

<b>Enclosure rating</b>	IP65 (EN 60529)
<b>Ambient operating temperature</b>	0 °C ... +55 °C
<b>Storage temperature</b>	-25 °C ... +70 °C
<b>Air humidity</b>	15 % ... 95 %, Non-condensing
<b>Vibration resistance</b>	5 g, 10 Hz ... 55 Hz (EN 60068-2-6)
<b>Shock resistance</b>	10 g, 16 ms (EN 60068-2-27)

## Other information

<b>Wave length</b>	850 nm
<b>Type of light</b>	Near-infrared (NIR), invisible

## Classifications

<b>ECLASS 5.0</b>	27272704
<b>ECLASS 5.1.4</b>	27272704
<b>ECLASS 6.0</b>	27272704
<b>ECLASS 6.2</b>	27272704
<b>ECLASS 7.0</b>	27272704
<b>ECLASS 8.0</b>	27272704
<b>ECLASS 8.1</b>	27272704
<b>ECLASS 9.0</b>	27272704
<b>ECLASS 10.0</b>	27272704
<b>ECLASS 11.0</b>	27272704
<b>ECLASS 12.0</b>	27272704
<b>ETIM 5.0</b>	EC002549

<b>ETIM 6.0</b>	EC002549
<b>ETIM 7.0</b>	EC002549
<b>ETIM 8.0</b>	EC002549
<b>UNSPSC 16.0901</b>	46171620

### Dimensional drawing (Dimensions in mm (inch))

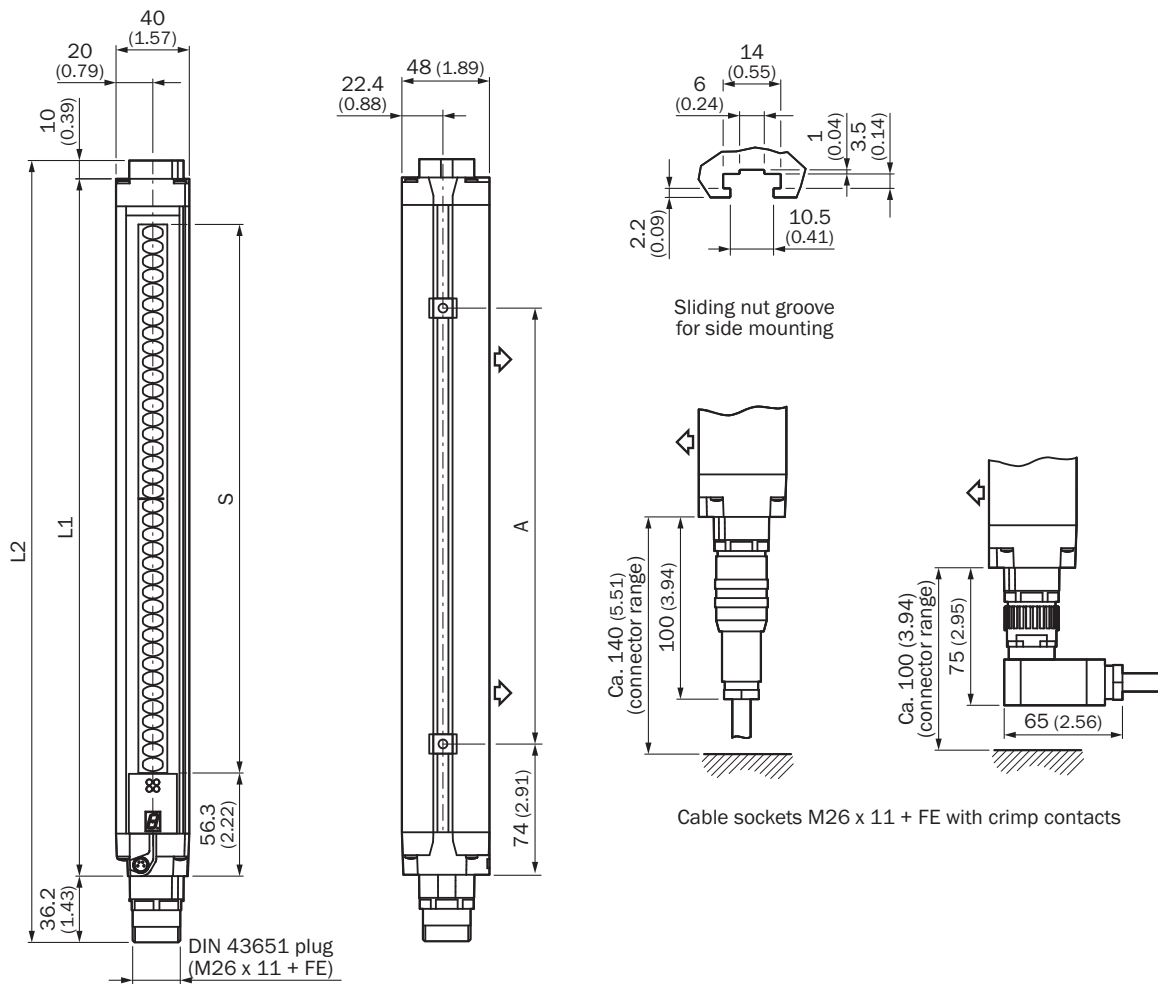











Illustration sender (receiver mirror image)

	<b>L1</b>	<b>L2</b>	<b>A</b>
300	381	427	224
450	532	578	374
600	682	728	524
750	833	879	674
900	984	1.030	824
1.050	1.134	1.180	974
1.200	1.283	1.329	1.124
1.350	1.435	1.481	1.274
1.500	1.586	1.632	1.424



	L1	L2	A
1.650	1.736	1.782	1.574
1.800	1.887	1.933	1.724

## Recommended accessories

Other models and accessories → [www.sick.com/C4000\\_Palletizer](http://www.sick.com/C4000_Palletizer)

	Brief description	Type	Part no.
<b>Alignment aids</b>			
	Laser alignment aid for various sensors, laser class 2 (IEC 60825). Do not look into the beam!, 19 mm x 67.3 mm x 66.9 mm	AR60	1015741
	Adapter AR60 for housing cross-section 48 mm x 40 mm	AR60 adapter, 48x40	4032461
	Adapter AR60 for housing cross-section 48 mm x 40 mm in PU3H device column	AR60 adapter, 48x40, PU3H	4056731
<b>Optics cloths</b>			
	Cloth for cleaning optical surfaces	Lens cloth	4003353
<b>Mounting brackets and plates</b>			
	4 pieces, Mounting kit 1, mounting bracket, rigid, L-shaped, including fixing screws and washers	BEF-3WNGBAST4	7021352
<b>Plug connectors and cables</b>			
	<ul style="list-style-type: none"> <li><b>Connection type head A:</b> Female connector, M26, 12-pin, straight</li> <li><b>Description:</b> Unshielded</li> <li><b>Connection systems:</b> Crimp contacts</li> <li><b>Permitted cross-section:</b> 0.5 mm<sup>2</sup> ... 1.5 mm<sup>2</sup></li> <li><b>Note:</b> 12 crimping contacts enclosed</li> </ul>	DOS-0612G000GA3KM0	6020757
	<ul style="list-style-type: none"> <li><b>Connection type head A:</b> Female connector, M26, 12-pin, angled</li> <li><b>Description:</b> Unshielded</li> <li><b>Connection systems:</b> Crimp contacts</li> <li><b>Permitted cross-section:</b> 0.5 mm<sup>2</sup> ... 1.5 mm<sup>2</sup></li> <li><b>Note:</b> 12 crimping contacts enclosed</li> </ul>	DOS-0612W000GA3KM0	6020758
	<ul style="list-style-type: none"> <li><b>Connection type head A:</b> Male connector, M26, 12-pin, straight</li> <li><b>Description:</b> Unshielded</li> <li><b>Connection systems:</b> Crimp contacts</li> <li><b>Permitted cross-section:</b> 0.5 mm<sup>2</sup> ... 1.5 mm<sup>2</sup></li> <li><b>Note:</b> 12 crimping contacts enclosed</li> </ul>	STE-0612G000GA3KM0	6021191
	<ul style="list-style-type: none"> <li><b>Connection type head A:</b> Male connector, M26, 12-pin, angled</li> <li><b>Description:</b> Unshielded</li> <li><b>Connection systems:</b> Crimp contacts</li> <li><b>Permitted cross-section:</b> 0.5 mm<sup>2</sup> ... 1.5 mm<sup>2</sup></li> <li><b>Note:</b> 12 crimping contacts enclosed</li> </ul>	STE-0612W000GA3KM0	6021192

	Brief description	Type	Part no.
Terminal and alignment brackets			
	4 pieces, Mounting kit 6, side bracket, rotatable, zinc diecast	BEF-1SHABAZN4	2019506
	4 pieces, Omega bracket, rotatable, fixable with only one screw, for mounting on the swivel mount	BEF-2SMMEAAL4	2044847
	4 pieces, Mounting kit 2, rotatable, swivel mount, Polyamide PA6	BEF-2SMMEAUKU4	2019659
Others			
	<ul style="list-style-type: none"> <li>• <b>Connection type head A:</b> Male connector, M8, 4-pin, straight</li> <li>• <b>Connection type head B:</b> Male connector, USB-A, straight</li> <li>• <b>Cable:</b> 2 m, 4-wire, PVC</li> <li>• <b>Description:</b> Unshielded, Configuration cable with integrated RS-232 transducer on USB for connecting a sensor configuration connection (M8, 4-pin) to the USB interface of a PC</li> </ul>	DSL-8U04G02M025KM1	6034574
	<ul style="list-style-type: none"> <li>• <b>Connection type head A:</b> Male connector, M8, 4-pin, straight</li> <li>• <b>Connection type head B:</b> Male connector, USB-A, straight</li> <li>• <b>Cable:</b> 10 m, 4-wire, PVC</li> <li>• <b>Description:</b> Unshielded, Configuration cable with integrated RS-232 transducer on USB for connecting a sensor configuration connection (M8, 4-pin) to the USB interface of a PC</li> </ul>	DSL-8U04G10M025KM1	6034575
	<ul style="list-style-type: none"> <li>• <b>Connection type head A:</b> Female connector, M26, 12-pin, straight</li> <li>• <b>Connection type head B:</b> Flying leads</li> <li>• <b>Signal type:</b> Sensor/actuator cable</li> <li>• <b>Cable:</b> 20 m, 12-wire, PVC</li> <li>• <b>Description:</b> Sensor/actuator cable, unshielded</li> <li>• <b>Connection systems:</b> Flying leads</li> </ul>	DOL-0612G20M075KM0	2022549
	<ul style="list-style-type: none"> <li>• <b>Connection type head A:</b> Female connector, M26, 12-pin, straight</li> <li>• <b>Connection type head B:</b> Flying leads</li> <li>• <b>Signal type:</b> Sensor/actuator cable</li> <li>• <b>Cable:</b> 15 m, 12-wire, PVC</li> <li>• <b>Description:</b> Sensor/actuator cable, unshielded</li> <li>• <b>Connection systems:</b> Flying leads</li> </ul>	DOL-0612G15M075KM0	2022548
	<ul style="list-style-type: none"> <li>• <b>Connection type head A:</b> Female connector, M26, 12-pin, straight</li> <li>• <b>Connection type head B:</b> Flying leads</li> <li>• <b>Signal type:</b> Sensor/actuator cable</li> <li>• <b>Cable:</b> 10 m, 12-wire, PVC</li> <li>• <b>Description:</b> Sensor/actuator cable, unshielded</li> <li>• <b>Connection systems:</b> Flying leads</li> </ul>	DOL-0612G10M075KM0	2022547
	<ul style="list-style-type: none"> <li>• <b>Connection type head A:</b> Female connector, M26, 12-pin, straight</li> <li>• <b>Connection type head B:</b> Flying leads</li> <li>• <b>Cable:</b> 5 m, PVC</li> <li>• <b>Description:</b> Unshielded</li> <li>• <b>Connection systems:</b> Flying leads</li> <li>• <b>Note:</b> Without EFI: Pin 9 and 10 not connected</li> </ul>	DOL-0610G05M075KM1	2046888
	<ul style="list-style-type: none"> <li>• <b>Connection type head A:</b> Female connector, M26, 12-pin, straight</li> <li>• <b>Connection type head B:</b> Flying leads</li> <li>• <b>Cable:</b> 10 m, PVC</li> <li>• <b>Description:</b> Unshielded</li> <li>• <b>Connection systems:</b> Flying leads</li> <li>• <b>Note:</b> Without EFI: Pin 9 and 10 not connected</li> </ul>	DOL-0610G10M075KM1	2046889

	Brief description	Type	Part no.
	<ul style="list-style-type: none"> <li>• <b>Connection type head A:</b> Female connector, M26, 12-pin, straight</li> <li>• <b>Connection type head B:</b> Flying leads</li> <li>• <b>Signal type:</b> Sensor/actuator cable</li> <li>• <b>Cable:</b> 5 m, 12-wire, PVC</li> <li>• <b>Description:</b> Sensor/actuator cable, unshielded</li> <li>• <b>Connection systems:</b> Flying leads</li> </ul>	DOL-0612G05M075KM0	2022545
Switching amplifiers			
	<ul style="list-style-type: none"> <li>• <b>Applications:</b> Functionality upgrade</li> <li>• <b>Compatible sensor types:</b> C4000 safety light curtains</li> <li>• <b>Description:</b> Upgrades the C4000 Standard, Advanced, Palletizer, Entry/Exit, and Fusion to include the functions defined in the technical specifications, e.g., bypass, operating mode switching, and PSDI in the case of C4000 Standard, Advanced.</li> </ul>	UE402	1023577

## SICK AT A GLANCE

SICK is one of the leading manufacturers of intelligent sensors and sensor solutions for industrial applications. A unique range of products and services creates the perfect basis for controlling processes securely and efficiently, protecting individuals from accidents and preventing damage to the environment.

We have extensive experience in a wide range of industries and understand their processes and requirements. With intelligent sensors, we can deliver exactly what our customers need. In application centers in Europe, Asia and North America, system solutions are tested and optimized in accordance with customer specifications. All this makes us a reliable supplier and development partner.

Comprehensive services complete our offering: SICK LifeTime Services provide support throughout the machine life cycle and ensure safety and productivity.

For us, that is “Sensor Intelligence.”

## WORLDWIDE PRESENCE:

Contacts and other locations –[www.sick.com](http://www.sick.com)