



IMP12-1B5PPVC0F

IMP

INDUCTIVE PROXIMITY SENSORS

SICK
Sensor Intelligence.



Ordering information

Type	Part no.
IMP12-1B5PPVCOF	6050135

Other models and accessories → www.sick.com/IMP

Illustration may differ



Detailed technical data

Features

Housing	Metric
Thread size	M12 x 1
Diameter	Ø 12 mm
Pressure resistance	≤ 500 bar
Sensing range S_n	1.5 mm
Safe sensing range S_a	1.2 mm
Installation type	Flush
Switching frequency	600 Hz
Connection type	Male connector M12, 4-pin
Switching output	PNP
Output function	Complementary
Electrical wiring	DC 4-wire
Enclosure rating	IP68 ¹⁾
Special features	High pressure resistant, Temperature resistance
Special applications	Hydraulic application

¹⁾ Sensing face.

Mechanics/electronics

Supply voltage	10 V DC ... 30 V DC
Ripple	≤ 20 % ¹⁾
Voltage drop	≤ 2 V ²⁾

¹⁾ Of V_S.

²⁾ With I_a = 200 mA.

³⁾ Typ. 8%.

⁴⁾ U_b = 20 ... 30 VDC.

⁵⁾ T_a = 23 °C ± 5 °C.

⁶⁾ -25 °C ... +70 °C.

⁷⁾ +70 °C...+100 °C.

⁸⁾ Front.

Time delay before availability	≤ 50 ms
Hysteresis	1 % ... 15 % ³⁾
Reproducibility	≤ 7 % ^{4) 5)}
Temperature drift (of S_r)	± 10 % ⁶⁾ ± 15 % ⁷⁾
EMC	According to EN 60947-5-2
Continuous current I_a	≤ 200 mA
Vacuum resistance	10 ⁻⁸ Torr ⁸⁾
Large sealing ring	5.3 mm x 2.4 mm
Size support ring	10 mm x 5.9 mm x 1 mm
Short-circuit protection	✓
Reverse polarity protection	✓
Shock and vibration resistance	30 g, 11 ms / 10 ... 55 Hz, 1 mm
Ambient operating temperature	-25 °C ... +100 °C
Housing material	Stainless steel V2A, DIN 1.4305 / AISI 303
Sensing face material	Ceramics, ZrO ₂
Sealing ring material	FPM
Housing length	93 mm
Thread length	75 mm
Tightening torque, max.	≤ 40 Nm

1) Of V_S.

2) With I_a = 200 mA.

3) Typ. 8%.

4) U_b = 20 ... 30 VDC.

5) T_a = 23 °C ± 5 °C.

6) -25 °C ... +70 °C.

7) +70 °C...+100 °C.

8) Front.

Safety-related parameters

MTTF_D	156 years
DC_{avg}	0%
T_M (mission time)	20 years

Reduction factors

Note	The values are reference values which may vary
St37 steel (Fe)	1
Stainless steel (V2A, 304)	Approx. 0.75
Aluminum (Al)	Approx. 0.2
Copper (Cu)	Approx. 0.12
Brass (Br)	Approx. 0.34

Installation note

Remark	Associated graphic see "Installation"
B	8 mm

C	12 mm
D	6 mm
F	12 mm

Classifications

ECLASS 5.0	27270101
ECLASS 5.1.4	27270101
ECLASS 6.0	27270101
ECLASS 6.2	27270101
ECLASS 7.0	27270101
ECLASS 8.0	27270101
ECLASS 8.1	27270101
ECLASS 9.0	27270101
ECLASS 10.0	27270101
ECLASS 11.0	27270101
ECLASS 12.0	27274001
ETIM 5.0	EC002714
ETIM 6.0	EC002714
ETIM 7.0	EC002714
ETIM 8.0	EC002714
UNSPSC 16.0901	39122230

Installation note

Flush installation

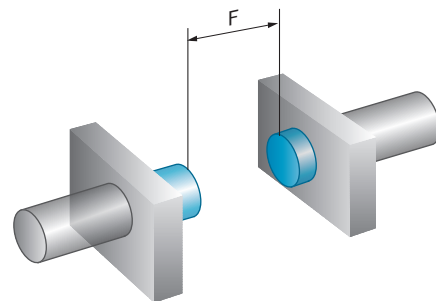
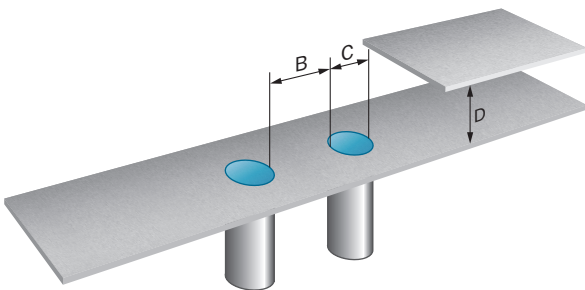

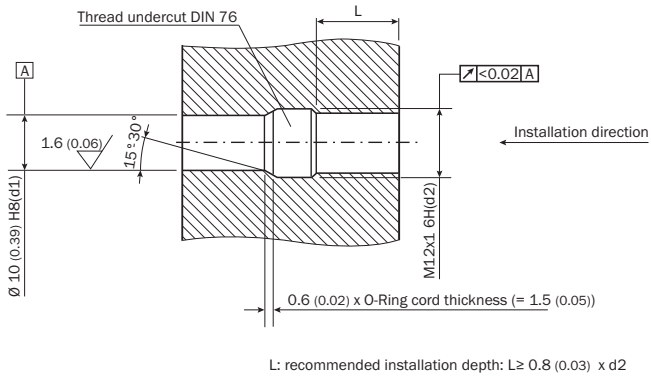

Connection diagram

Cd-006

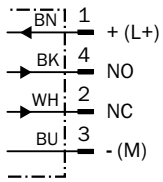

Dimensional drawing (Dimensions in mm (inch))

IMP12-xxxxxxxF, 93 mm

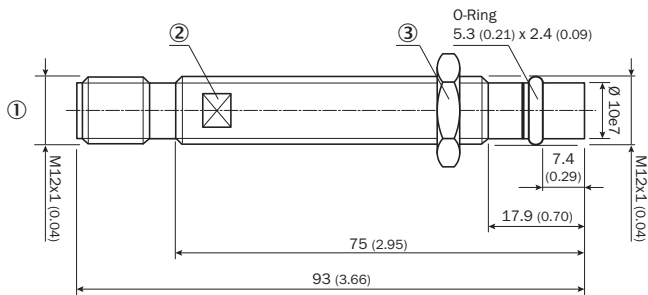









- ① Male connector M12, 4-pin
- ② Width across 10
- ③ Width across 17

Recommended accessories

Other models and accessories → www.sick.com/IMP

	Brief description	Type	Part no.
Other mounting accessories			
	5327494	O-ring IMP12	5327494
	5327496	Support ring IMP12	5327496

	Brief description	Type	Part no.
Others			
	<ul style="list-style-type: none"> • Connection type head A: Female connector, M12, 4-pin, straight, A-coded • Connection type head B: Flying leads • Signal type: Sensor/actuator cable • Cable: 2 m, 4-wire, PUR, halogen-free • Description: Sensor/actuator cable, unshielded • Application: Zones with oils and lubricants, Drag chain operation, Robot 	YF2A14-020UB3XLEAX	2095607
	<ul style="list-style-type: none"> • Connection type head A: Female connector, M12, 4-pin, straight, A-coded • Connection type head B: Flying leads • Signal type: Sensor/actuator cable • Cable: 5 m, 4-wire, PUR, halogen-free • Description: Sensor/actuator cable, unshielded • Application: Zones with oils and lubricants, Drag chain operation, Robot 	YF2A14-050UB3XLEAX	2095608
	<ul style="list-style-type: none"> • Connection type head A: Female connector, M12, 4-pin, angled, A-coded • Connection type head B: Flying leads • Signal type: Sensor/actuator cable • Cable: 2 m, 4-wire, PUR, halogen-free • Description: Sensor/actuator cable, unshielded • Application: Zones with oils and lubricants, Drag chain operation, Robot 	YG2A14-020UB3XLEAX	2095766
	<ul style="list-style-type: none"> • Connection type head A: Female connector, M12, 4-pin, angled, A-coded • Connection type head B: Flying leads • Signal type: Sensor/actuator cable • Cable: 5 m, 4-wire, PUR, halogen-free • Description: Sensor/actuator cable, unshielded • Application: Zones with oils and lubricants, Drag chain operation, Robot 	YG2A14-050UB3XLEAX	2095767
	<ul style="list-style-type: none"> • Connection type head A: Female connector, M12, 4-pin, straight, A-coded • Connection type head B: Flying leads • Signal type: Sensor/actuator cable • Cable: 2 m, 4-wire, PVC • Description: Sensor/actuator cable, unshielded • Application: Zones with chemicals 	YF2A14-020VB3XLEAX	2096234
	<ul style="list-style-type: none"> • Connection type head A: Female connector, M12, 4-pin, straight, A-coded • Connection type head B: Flying leads • Signal type: Sensor/actuator cable • Cable: 5 m, 4-wire, PVC • Description: Sensor/actuator cable, unshielded • Application: Zones with chemicals 	YF2A14-050VB3XLEAX	2096235
	<ul style="list-style-type: none"> • Connection type head A: Female connector, M12, 4-pin, angled, A-coded • Connection type head B: Flying leads • Signal type: Sensor/actuator cable • Cable: 2 m, 4-wire, PVC • Description: Sensor/actuator cable, unshielded • Application: Zones with chemicals 	YG2A14-020VB3XLEAX	2095895
	<ul style="list-style-type: none"> • Connection type head A: Female connector, M12, 4-pin, angled, A-coded • Connection type head B: Flying leads • Signal type: Sensor/actuator cable • Cable: 5 m, 4-wire, PVC • Description: Sensor/actuator cable, unshielded • Application: Zones with chemicals 	YG2A14-050VB3XLEAX	2095897

SICK AT A GLANCE

SICK is one of the leading manufacturers of intelligent sensors and sensor solutions for industrial applications. A unique range of products and services creates the perfect basis for controlling processes securely and efficiently, protecting individuals from accidents and preventing damage to the environment.

We have extensive experience in a wide range of industries and understand their processes and requirements. With intelligent sensors, we can deliver exactly what our customers need. In application centers in Europe, Asia and North America, system solutions are tested and optimized in accordance with customer specifications. All this makes us a reliable supplier and development partner.

Comprehensive services complete our offering: SICK LifeTime Services provide support throughout the machine life cycle and ensure safety and productivity.

For us, that is “Sensor Intelligence.”

WORLDWIDE PRESENCE:

Contacts and other locations –www.sick.com