



DME5000-323

DME5000

LONG RANGE DISTANCE SENSORS

SICK
Sensor Intelligence.



Ordering information

Type	Part no.
DME5000-323	1025253

Other models and accessories → www.sick.com/DME5000



Detailed technical data

Features

Measuring range	0.15 m ... 300 m, on "diamond grade" reflective tape ¹⁾				
Target	Reflector				
Resolution	0.05 mm ... 5 mm				
Repeatability	2 mm ^{1) 2)}				
Measurement accuracy	± 5 mm				
Response time	6 ms				
Output time	2 ms				
Light source	Laser, red ³⁾ visible red light				
Type of light	Visible red light				
Laser class	2, complies with 21 CFR 1040.10 and 1040.11 except for the conformance according to "Laser Notice No. 50" from June 24, 2007 (IEC 60825-1:2014, EN 60825-1:2014)				
Typ. light spot size (distance)	130 mm (at 70 m) 270 mm (at 150 m) 360 mm (at 220 m)				
Max. movement speed	10 m/s				
Safety-related parameters	<table border="0"> <tr> <td style="padding-right: 20px;">MTTF_D</td> <td>101 years</td> </tr> <tr> <td>DC_{avg}</td> <td>0%</td> </tr> </table>	MTTF _D	101 years	DC _{avg}	0%
MTTF _D	101 years				
DC _{avg}	0%				

¹⁾ On "diamond grade" reflective tape.

²⁾ Statistical error 1 σ , environmental conditions constant, min. warm-up time 10 min.

³⁾ Average service life of 50,000 h at T_A = +25 °C.

Interfaces

Serial	✓, RS-422
Digital output	
Number	2

¹⁾ Max. 100 nF/20 mH.

²⁾ HIGH = > V_S - 3 V / LOW = < 2 V.

³⁾ HIGH = > 12 V / LOW = < 3 V.

⁴⁾ Not reverse-polarity protected.

Type	Push-pull: PNP/NPN
Maximum output current I_A	$\leq 100 \text{ mA}$ ^{1) 2)}
Multifunctional input (MF)	1 x MF ^{3) 4)}

¹⁾ Max. 100 nF/20 mH.

²⁾ HIGH = $> V_S - 3 \text{ V}$ / LOW = $< 2 \text{ V}$.

³⁾ HIGH = $> 12 \text{ V}$ / LOW = $< 3 \text{ V}$.

⁴⁾ Not reverse-polarity protected.

Electronics

Supply voltage U_B	DC 18 V ... 30 V, limit values
Current consumption	At 24 V DC $< 1,000 \text{ mA}$
Ripple	$< 5 \text{ V}_{pp}$ ¹⁾
Initialization time	1.5 s ²⁾
Indication	Display
Enclosure rating	IP65
Protection class	II ³⁾

¹⁾ May not fall short of or exceed V_S tolerances.

²⁾ After loss of reflector $< 1 \text{ s}$ at max. speed $V_{max} < 1 \text{ m/s}$.

³⁾ Reference voltage DC 32 V.

Mechanics

Dimensions (W x H x D)	61 mm x 101 mm x 176 mm
Housing material	Metal (zinc diecast)
Window material	Glass
Weight	Approx. 1,650 g
Connection type	Male connector, M16, 8-pin

Ambient data

Ambient temperature, operation	-40 °C ... +55 °C, operation with heating -40 °C ... +75 °C, operation with cooling case
Ambient temperature, storage	-25 °C ... +75 °C
Effect of air pressure	0.3 ppm/hPa
Effect of air temperature	1 ppm/K
Temperature drift	Typ. 0.1 mm/K
Typ. Ambient light immunity	$\leq 40,000 \text{ lx}$
Mechanical load	Shock: (EN 600 68-2-27 / -2-29) Sine: (EN 600 68-2-6) Noise: (EN 600 68-2-64)
Electromagnetic compatibility (EMC)	EN 61000-6-2, EN 55011

Classifications

ECLASS 5.0	27270801
ECLASS 5.1.4	27270801
ECLASS 6.0	27270801
ECLASS 6.2	27270801
ECLASS 7.0	27270801

ECLASS 8.0	27270801
ECLASS 8.1	27270801
ECLASS 9.0	27270801
ECLASS 10.0	27270801
ECLASS 11.0	27270801
ECLASS 12.0	27270916
ETIM 5.0	EC001825
ETIM 6.0	EC001825
ETIM 7.0	EC001825
ETIM 8.0	EC001825
UNSPSC 16.0901	41111613

Dimensional drawing (Dimensions in mm (inch))

DME5000 RS-422

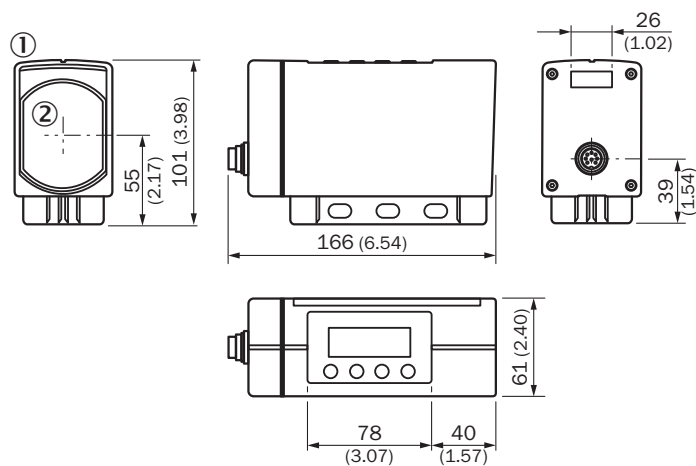

- ① LC display
- ② Center of optical axis

Working range diagram

DL1000 measuring range based on measurement cycle time and reflector type



Connection type

DME4/5xxx SSI/RS-422 Connector M16, 8-pin



Connection diagram

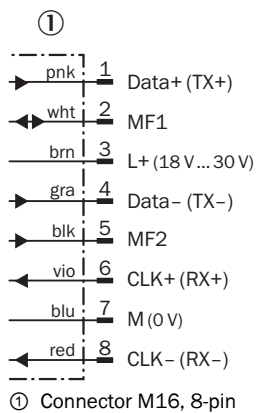



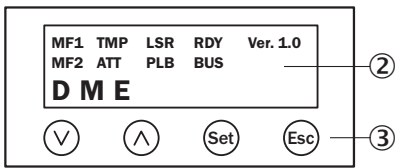

Adjustment possible



- ② LC display
- ③ Keypad

Recommended accessories

Other models and accessories → www.sick.com/DME5000

	Brief description	Type	Part no.
Reflectors			
	Reflector plate, "diamond grade" reflective tape, 665 mm x 665 mm, base plate material: aluminum, screw connection, Screw-on, 4 hole mounting	PL560DG	1016806
Terminal and alignment brackets			
	Alignment unit for DME5000, stainless steel (1.4541), incl. mounting material, additional base plate mounting kit required, mounting hardware included	BEF-AH-DME	2027721
Others			
	<ul style="list-style-type: none"> • Connection type head A: Female connector, M12, 5-pin, A-coded • Connection type head B: Flying leads • Signal type: Power, CAN • Cable: 5 m, 5-wire • Description: Power, CAN, unshielded 	DOL-1205-G05M_Can	6021166
	<ul style="list-style-type: none"> • Connection type head A: Female connector, M12, 5-pin, straight, A-coded • Connection type head B: Flying leads • Signal type: DeviceNet™ • Cable: 10 m, 5-wire, PUR, halogen-free • Description: DeviceNet™, shielded • Connection systems: Flying leads • Note: Shielded on pin 1 	YF2A14-100C1BXLEAX	6021175
	<ul style="list-style-type: none"> • Connection type head A: Female connector, M12, 8-pin, straight • Connection type head B: Flying leads • Cable: 2 m, 8-wire, PUR, halogen-free • Description: Shielded • Connection systems: Flying leads 	YF2A68-020XXXXLEAX	6032448
	<ul style="list-style-type: none"> • Connection type head A: Female connector, M12, 8-pin, straight • Connection type head B: Flying leads • Cable: 5 m, 8-wire, PUR, halogen-free • Description: Shielded 	YF2A68-050XXXXLEAX	6032449
	<ul style="list-style-type: none"> • Connection type head A: Female connector, M12, 8-pin, straight • Connection type head B: Flying leads • Cable: 10 m, 8-wire, PUR, halogen-free • Description: Shielded 	YF2A68-100XXXXLEAX	6032450

	Brief description	Type	Part no.
	<ul style="list-style-type: none"> • Connection type head A: Female connector, M12, 5-pin, straight, B-coded • Connection type head B: Flying leads • Signal type: PROFIBUS DP • Cable: 10 m, 2-wire, PUR, halogen-free • Description: PROFIBUS DP, twisted pair, shielded • Connection systems: Flying leads • Application: Zones with oils and lubricants 	DOL-1205-G10MQ	6026008
	<ul style="list-style-type: none"> • Connection type head A: Female connector, M12, 5-pin, straight, B-coded • Connection type head B: Flying leads • Signal type: PROFIBUS DP • Cable: 5 m, 2-wire, PUR, halogen-free • Description: PROFIBUS DP, twisted pair, shielded, Head A: female connector, M12, 5-pin, straight Head B: cable Cable: suitable for drag chain, PUR, halogen-free, shielded, 2 x 0.34 mm², Ø 8.0 mm • Connection systems: Flying leads • Application: Zones with oils and lubricants 	DOL-1205-G05MQ	6026006
	<ul style="list-style-type: none"> • Connection type head A: Male connector, M12, 4-pin, straight, B-coded • Signal type: PROFIBUS DP • Description: PROFIBUS DP, terminal resistor 	STE-END-Q	6021156
	<ul style="list-style-type: none"> • Connection type head A: Female connector, M12, 5-pin, straight, B-coded • Connection type head B: Flying leads • Signal type: PROFIBUS DP • Cable: 15 m, 2-wire, PUR, halogen-free • Description: PROFIBUS DP, twisted pair, shielded • Connection systems: Flying leads • Application: Zones with oils and lubricants 	DOL-1205-G15MQ	6032637
	<ul style="list-style-type: none"> • Connection type head A: Male connector, M12, 5-pin, straight, B-coded • Connection type head B: Flying leads • Signal type: PROFIBUS DP • Cable: 5 m, 2-wire, PUR, halogen-free • Description: PROFIBUS DP, twisted pair, shielded • Note: Wire shield Al-Pt film, overall shield C-screen tin-plated • Application: Zones with oils and lubricants, Drag chain operation 	STL-1205-G05MQ	6026005
	<ul style="list-style-type: none"> • Connection type head A: Male connector, M12, 5-pin, straight, B-coded • Connection type head B: Flying leads • Signal type: PROFIBUS DP • Cable: 10 m, 2-wire, PUR, halogen-free • Description: PROFIBUS DP, twisted pair, shielded • Note: Wire shield Al-Pt film, overall shield C-screen tin-plated • Application: Zones with oils and lubricants, Drag chain operation 	STL-1205-G10MQ	6026007
	<ul style="list-style-type: none"> • Connection type head A: Male connector, M12, 5-pin, straight, B-coded • Connection type head B: Flying leads • Signal type: PROFIBUS DP • Cable: 15 m, 2-wire, PUR, halogen-free • Description: PROFIBUS DP, twisted pair, shielded • Application: Zones with oils and lubricants, Drag chain operation 	STL-1205-G15MQ	6036898
	<ul style="list-style-type: none"> • Connection type head A: Female connector, M12, 5-pin, straight • Connection type head B: Flying leads • Signal type: CANopen • Cable: 6 m • Description: CANopen, shielded 	DOL-1205-G06MK	6028326
	<ul style="list-style-type: none"> • Connection type head A: Female connector, 7/8", 5-pin, straight • Signal type: DeviceNet™, CANopen • Description: DeviceNet™, CANopen, terminal resistor, shielded • Permitted cross-section: ≤ 1.5 mm² • Note: For field bus technology 	DOS-7805-GKEND	6028329
	<ul style="list-style-type: none"> • Connection type head A: Female connector, M16, 8-pin, straight • Connection type head B: Flying leads • Cable: 5 m, PUR, halogen-free • Description: Shielded 	YF2Z18-050XXXXLEBX	2026742

	Brief description	Type	Part no.
	<ul style="list-style-type: none">• Connection type head A: Female connector, M16, 8-pin, straight• Connection type head B: Flying leads• Cable: 10 m, PUR, halogen-free• Description: Shielded	YF2Z18-100XXXXLEBX	2027193

SICK AT A GLANCE

SICK is one of the leading manufacturers of intelligent sensors and sensor solutions for industrial applications. A unique range of products and services creates the perfect basis for controlling processes securely and efficiently, protecting individuals from accidents and preventing damage to the environment.

We have extensive experience in a wide range of industries and understand their processes and requirements. With intelligent sensors, we can deliver exactly what our customers need. In application centers in Europe, Asia and North America, system solutions are tested and optimized in accordance with customer specifications. All this makes us a reliable supplier and development partner.

Comprehensive services complete our offering: SICK LifeTime Services provide support throughout the machine life cycle and ensure safety and productivity.

For us, that is “Sensor Intelligence.”

WORLDWIDE PRESENCE:

Contacts and other locations –www.sick.com